



ARTHUR HOLM

DynamicVision

Motorised wall mount for videoconference cameras

AHDV01 / AHDV02

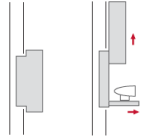

FEATURES

- Motorised wall mount for videoconference cameras
- AHDV01: Upward moving cover
- AHDV02: Downward moving cover
- Compatible with the most popular videoconference cameras
- Cover for veneering
- RS-422 and Infrared controllable
- Easy to install

GENERAL

DynamicVision is an efficient motorised solution to hide videoconference cameras and improving the room design. The DynamicVision is designed to be adapted to the room décor. Its fabric mounting system allows an easy mount of the fabric of your choice onsite. The DynamicVision can also be veneered with a maximum veneer load of 2.5kg/ 5.5lb. The camera enclosure is controllable through RS-422 (AHnet) and Infrared. AHLINK to diagnose and configure the unit.

DynamicVision provides the ideal solution to conceal videoconference cameras while improving the interior design of the conference room with its easily adaptable front enclosure that can be covered with various materials. The pre-installation frame is the perfect solution for coordination between system integrators and architects or constructors.

The camera enclosure is activated via RS-422 and infrared. AHLINK to diagnose and configure the unit. It neatly stores the camera away when not required, both protecting the camera and securing the work environment. The front enclosure moves vertically to expose the camera while moving the camera moves forward simultaneously to free the camera lines from the enclosure. DynamicVision is the perfect solution for system integrators, architects, interior designers and space planners.

ARTHUR HOLM

Albiral Display Solutions SL · Fàtima, 25 Sant Hipòlit de Voltregà 08512 Barcelona, Spain · +34 938 502 376 · marketing@arthurholm.com · www.arthurholm.com
Arthur Holm is a registered brand of Albiral Display Solutions SL. Specifications subject to change without previous notice.

Technology serving Design

TECHNICAL SPECIFICATIONS

AHDV01 / AHDV02

Engine

Control Up/Down	RS-422
	AHLink
	IR remote control

Electrical

External power supply	100-240Vac, 50/60Hz, 12Vdc
Power consumption	25W

OPTIONS

- AHDV01:
Motorised camera wall mount enclosure for videoconference cameras. Upward moving cover.
Controls: AHLink, contact closure, AHnet, RS-422 and Infrared remote control.
- AHDV02:
Motorised camera wall mount enclosure for videoconference cameras. Downward moving cover.
Controls: AHLink, contact closure, AHnet, RS-422 and Infrared remote control.

CERTIFICATIONS

- CE
- FCC

WARRANTY

- 2 years general warranty

AHDV01: CONSULTANTS, ARCHITECTS AND ENGINEERS SPECIFICATIONS

The motorised holder and cover up for videoconference cameras shall have tray support that slides in and out and the cover shall move vertically upwards. The cover shall be made of aluminum and shall be prepared for veneering. The cover shall allow a maximum veneer load of 2.5kg/ 5.5lb.

The system shall be controlled via infrared, contact closure and RS-422.

AHDV02: CONSULTANTS, ARCHITECTS AND ENGINEERS SPECIFICATIONS

The motorised holder and cover up for videoconference cameras shall have tray support that slides in and out and the cover shall move vertically downwards. The cover shall be made of aluminum and shall be prepared for veneering. The cover shall allow a maximum veneer load of 2.5kg/ 5.5lb.

The system shall be controlled via infrared, contact closure and RS-422.

ARTHUR HOLM

Albiral Display Solutions SL · Fàtima, 25 Sant Hipòlit de Voltregà 08512 Barcelona, Spain · +34 938 502 376 · marketing@arthurholm.com · www.arthurholm.com
Arthur Holm is a registered brand of Albiral Display Solutions SL. Specifications subject to change without previous notice.

Technology serving Design

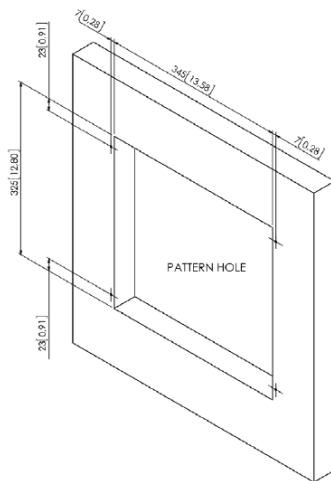
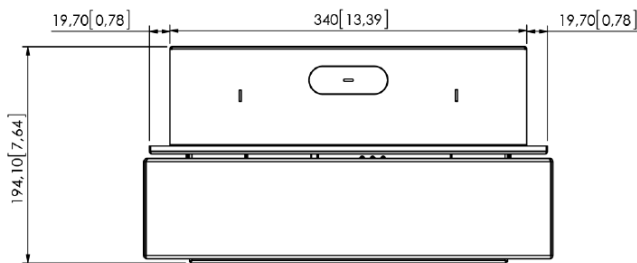
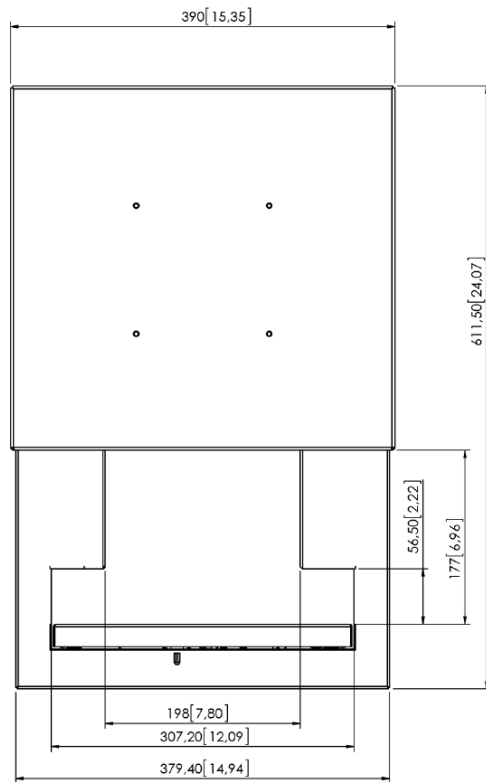
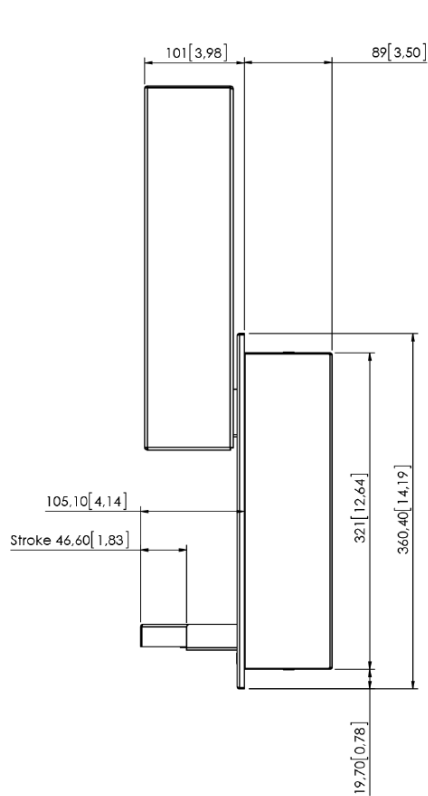

MAXIMUM CAMERA DIMENSIONS

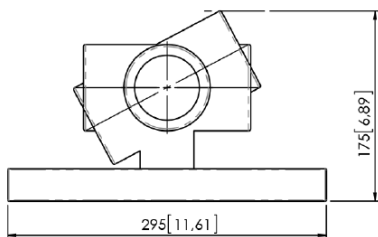

DIMENSION INCLUDING CONNECTORS

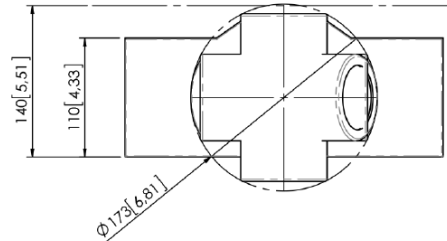

ARTHUR HOLM

Albiral Display Solutions SL · Fàtima, 25 Sant Hipòlit de Voltregà 08512 Barcelona, Spain · +34 938 502 376 · marketing@arthurholm.com · www.arthurholm.com
 Arthur Holm is a registered brand of Albiral Display Solutions SL. Specifications subject to change without previous notice.

Technology serving Design

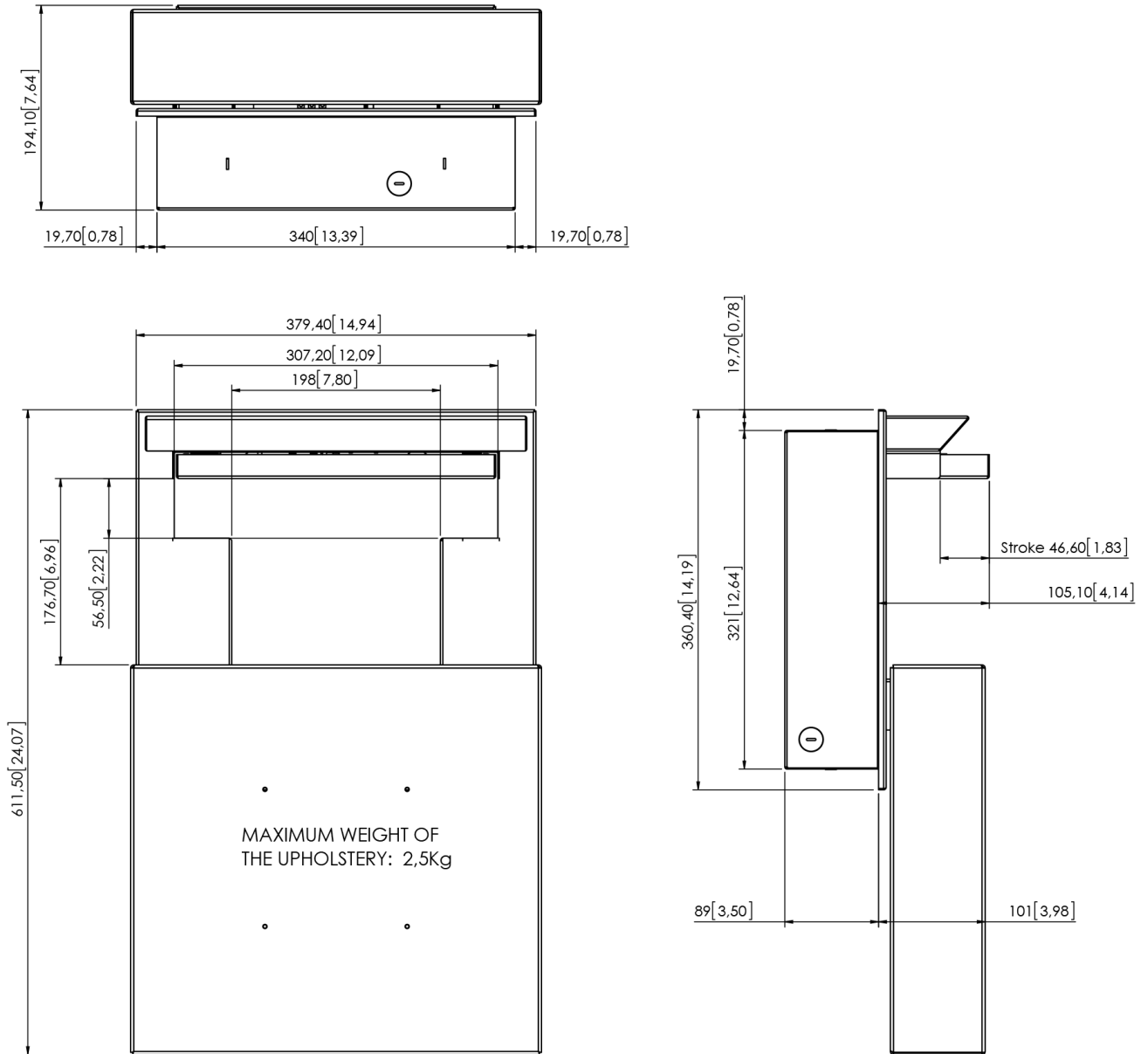

ARTHUR HOLM

Albiral Display Solutions SL · Fàtima, 25 Sant Hipòlit de Voltregà 08512 Barcelona, Spain · +34 938 502 376 · marketing@arthurholm.com · www.arthurholm.com
 Arthur Holm is a registered brand of Albiral Display Solutions SL. Specifications subject to change without previous notice.

Technology serving Design