

AH1

Manually foldable display



FEATURES

- Manually foldable from 70° to 0°
- Totally adjustable position
- No need to modify desk surface
- USB pass through
- Maintenance free
- HDCP compliant
- Easy to install

GENERAL

AH1 manually foldable displays have been designed to be placed on tables or desks of any material.

AH1 is a manually foldable aluminium monitor in anodised finish and dark cast iron base with a ush anti glare protection glass screened with an elegant black frame.

AH1 is the ideal solution for auditorium, tele presence, meeting and conference rooms and information counters.

With a height that can be easily adjusted, they do not require structural changes on the table desk and can also be interactive optionally.

AH1 is available in 12", "17" and 22" sizes.

TECHNICAL SPECIFICATIONS

Display

Size	FULL HD 17.3" TFT Active Matrix, widescreen
Resolution	1920 (h) x 1080 (v)
Brightness	400 cd/m2
Contrast ratio	600:1
Pixel	0.1989 (h) x 0.1989 (v) mm
Viewing angle	60°/80° (u/d) / 80°/80° (l/r)
Viewing area	381.888 (h) x 214.812 (v) mm
LED backlight lifespan	50.000 hrs
Response time	Tr 37 ms, Tf 3 ms
Temperature <i>(operating/storage)</i>	Operating 0°C – +40°C Storage -20°C – +60°C

Materials

Cabinet	Milled aluminium with anodised finishing and dark gray cast iron base. Flush antiglare protection glass with elegant black marking
---------	--

Connectivity

Input signal	DVI-I (1 input) – HDCP Compliant DVI-D (1 input) – HDCP Compliant
--------------	--

Electrical

Low voltage <i>(external power supply)</i>	100-240Vac, 47/63Hz, 12Vdc
Power consumption	50W

Mechanical

Monitor Dimensions:	
Screen	443 x 333 x 57 mm [17.44"x13.11"x2.24"]
Weight	15.1 kg / 33.2 lbs
Shipping Dimensions:	
Weight	16.1 kg / 35.5 lbs
Shipping Box	587 x 491 x 185 mm

OPTIONS

- Touch screen

CERTIFICATIONS

- CE

WARRANTY

- 2 years general warranty

CONNECTIVITY PANEL

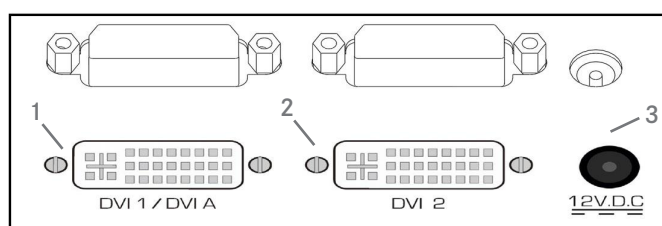

CONNECTIVITY

- 1- DVI-1 /DVI-A video input - analog /digital
- 2- DVI-2 video input - digital
- 3- 12 D.C. power supply input

ARCHITECT'S SPECIFICATIONS

Professional manually foldable 17.3" monitor. Solid block of aluminum monitor housing in natural anodized finishing, with rounded corners design. Cast iron base. Front anti-reflective black-edged glass. Desk mounting. Screen facing up when folded. Hidden cables, no visible screws or ventilation holes.

DVI-I and DVI-D connectors. HDCP compliant input. USB in the side of the screen pass-through cabling for clean USB connection in the table. External power supply.

ARTHUR HOLM

Albiral Display Solutions SL · Fàtima, 25 Sant Hipòlit de Voltregà 08512 Bcelona, Spain · +34 938 502 376 · marketing@arthurholm.com
www.arthurholm.com

Arthur Holm is a registered brand of Albiral Display Solutions SL. Specifications subject to change without previous notice.

GENERAL DIMENSIONS

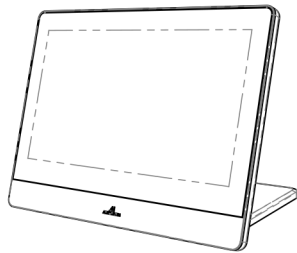
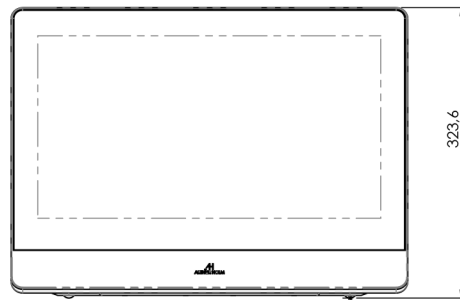
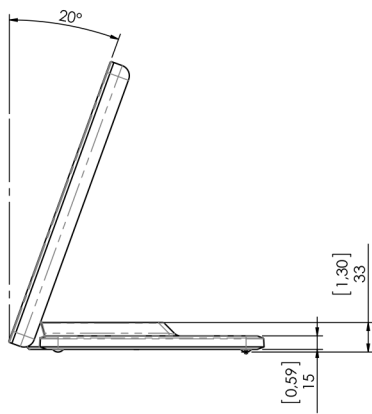

ORIENTATIVE VIEW

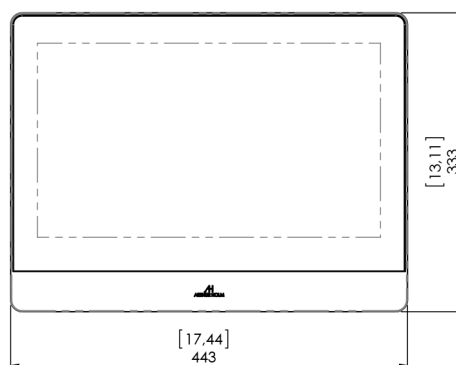
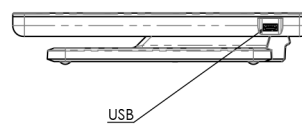
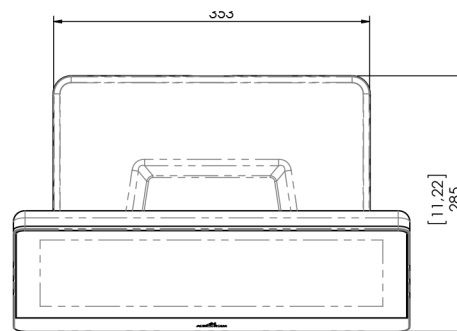

ARTHUR HOLM

Albiral Display Solutions SL · Fàtima, 25 Sant Hipòlit de Voltregà 08512 Bcelona, Spain · +34 938 502 376 · marketing@arthurholm.com
www.arthurholm.com

Arthur Holm is a registered brand of Albiral Display Solutions SL. Specifications subject to change without previous notice.