

DB2

HDCP compliant retractable motorised monitor

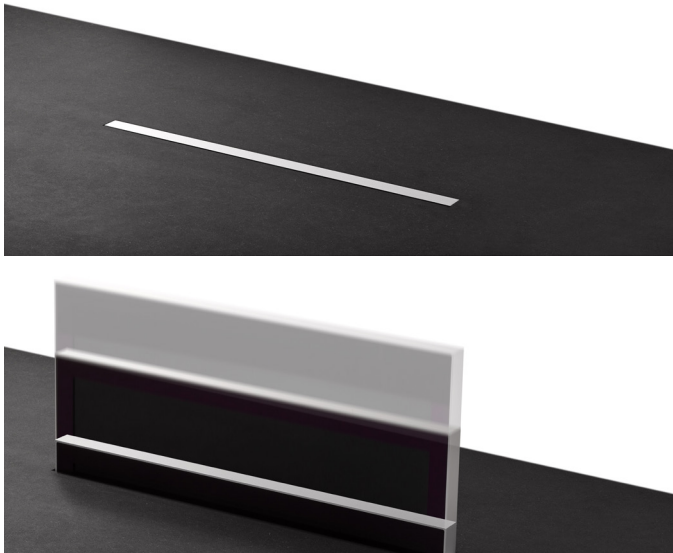
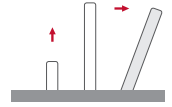

FEATURES

- Vertical motorised monitor with up to 20° inclination
- Adjustable screen angle tilt
- No cover plate required (monitor completely streamlined within the furniture)
- One operation sensor on top of the aluminium housing (to rise and lower the screen and adjust the tilt angle)
- 17 mm maximum thickness
- Front double sided anti-reflective 2 sides coating 2 mm black edged glass
- Can be veneered
- Interactive Setup Display (ISD)
- Maintenance free
- HDCP compliant
- Energy saving design, low consumption video controller
- Serial control and remote diagnosis
- Wireless connectivity for setup and control
- Individual monitor addressing
- Auto Mechanical Movement Calibration (AH-AMMC)

GENERAL

Arthur Holm's DB2 is a motorised retractable monitor range that creates minimum impact on the furniture's design. It is easy to integrate, intuitive to use (one simple operation sensor located on the top of the monitor) and almost invisible (no cover plate, neatly streamlined into furniture) when not operating. DB2 provides a harmonious silent drive with variable speeds. With a maximum thickness of 20 mm, this monitor range is elegant, beautiful from all angles and can be veneered for a seamless integration into furniture, creating a long lasting user's experience and delivering an exceptional images quality. We have selected the best possible aluminium finishing specifications in the world, providing the maximum technical and visual performance.

The screen is protected with an anti-reflective 2 side coating 2 mm black edged glass. DB2 are available from 10" to 23.8" with 2 DVI-HDCP compliant inputs and equipped with an Interactive Setup Display (ISD) allowing the control, setup and diagnose of the monitors. Monitors provide RS-422 I/O allowing the remote control of movements, speed, safety settings, brightness, contrast and backlight. The monitors are equipped with Auto Mechanical Movement Calibration (AH-AMMC). The use of the Arthur Holm's ERT will enable the address configuration of all the monitors installed in a table by simply pressing a button. The AHlink Android and iOS App allows getting the monitor's serial number without removing the unit from the table and allows access to the setup and control menu.

ARTHUR HOLM

Albiral Display Solutions SL · Fàtima, 25 Sant Hipòlit de Voltregà 08512 Barcelona, Spain · +34 938 502 376 · marketing@arthurholm.com · www.arthurholm.com
Arthur Holm is a registered brand of Albiral Display Solutions SL. Specifications subject to change without previous notice.

Technology serving Design

Display

Size	FULL HD 10" TFT Active Matrix, widescreen format. LED backlight
Resolution	1920 (h) x 1080 (v)
Brightness	300 cd/m2
Contrast ratio	1000:1
Pixel	0.11475 (h) x 0.11475 (v) mm
Viewing angle	60°/80°(u/d) 80°/80°(l/r)
Viewing area	220.32 (h) x 123.93 (v) mm
LED backlight lifespan	40,000 hrs
Response time	Tr+Tf 26 ms
Temperature (operating/storage)	Operating 0°C ~+40°C Storage -20°C ~+60°C

Materials

Monitor housing	Solid mechanised aluminium housing with anodised finish. Front black serigraphed glass
-----------------	--

Connectivity

Input signal	DVI-I (1 input) – HDCP compliant DVI-D (1 input) – HDCP compliant
RJ45 CAT6 (with loop)	Addressable RS422 monitor control by AHnet protocol
GPI (SubD9)	Up/Down control
USB	For service

Control

RJ45, RS-422 (I/O), AHNet protocol
Addressing
Termination switch
GPI
IR Remote control (monitor adjustments): 1/5

Movement's Control

User interface on monitor	(Up/Down) Capacitive touch sensor
Remote	RS-422 I/O, GPI

Accessories

ERT	Ethernet Interface Unit
-----	-------------------------

Mechanical

Monitor Dimensions:	
Screen	258 x 167 x 17 mm [10.16" x 6.57" x 0.67"]
Top frame	258 x 17 mm [10.16" x 0.67"]
Housing below the table	347 x 607 x 80 mm [13.66" x 23.90" x 3.15"]
Weight	12 Kg / 26.45 Lbs
Shipping Dimensions:	
Weight	13 Kg / 28.65 Lbs
Shipping Box	625 x 175 x 715 mm [24.60" x 6.8" x 28.14"]

OPTIONS

- Projected capacitive multi-touch screen
- Black anodised
- Gold finish
- Bronze finish
- Painted
- Aluminium cover plate
- DynamicLoop

WARRANTY

- 5 years limited warranty
- 2 years general warranty

CERTIFICATIONS

- CE
- FCC
- IECEE

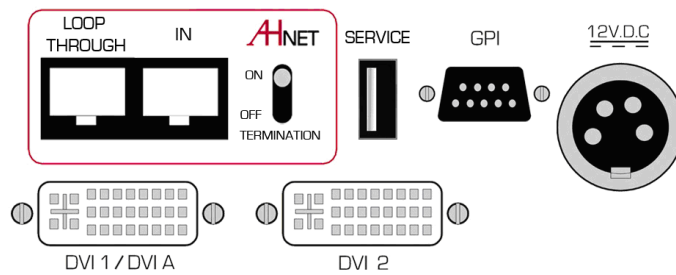

INTERACTIVE SETUP DISPLAY (ISD)

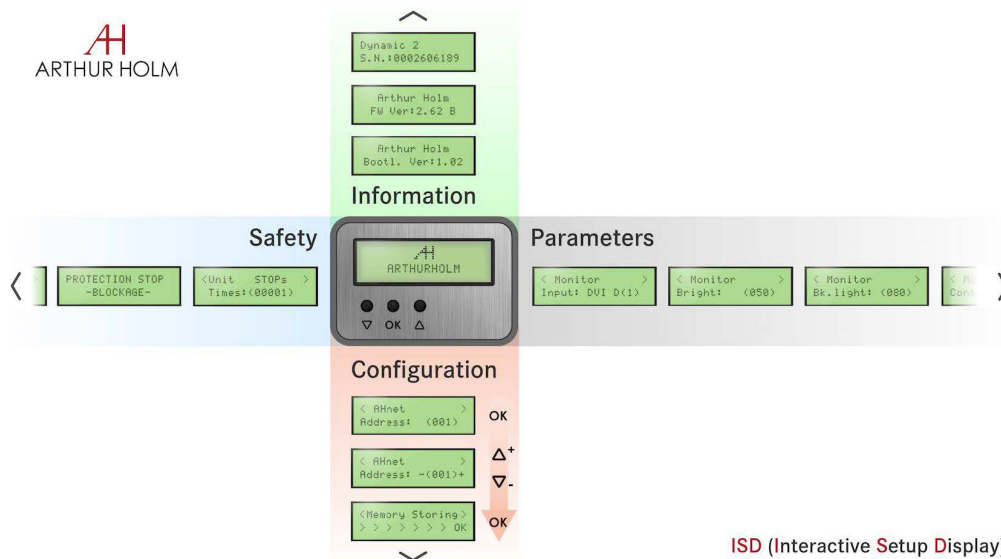

ISD (Interactive Setup Display)

CONSULTANTS, ARCHITECTS AND ENGINEERS SPECIFICATIONS

Vertically retractable motorised 10" Full HD professional monitor. The monitor housing shall be made of milled anodised aluminium with a maximum thickness of 17 mm and the screen shall be protected with an anti-reflecting 2 side coating black edged 2 mm glass. The monitor shall allow its installation into furniture opening with a maximum width of 21 mm and shall be designed to be veneered to match the furniture’s surface.

The monitor housing shall be flush with the table when the monitor is in recessed position. A capacitive button that shall be placed at the top of the monitor shall activate the monitor’s movements. The monitor shall have a brightness of 300 cd/m2, a contrast ratio of 1000:1 and a backlight lifespan of 40,000 hours.

The monitor shall provide 2 DVI HDCP inputs by a licensed HDCP monitor manufacturer. The monitor shall provide an addressable RS-422 and an easy to read Interactive Setup Display (ISD) to access the safety parameters, the setup of the speed and the control of the brightness, contrast and backlight. The monitor shall be able to run an auto adjustment program to reset the factory setups.

The monitor shall provide a USB port for firmware upgrades. The monitor shall be controlled by a wireless Android and iOS App providing information about the monitor’s serial number, and providing access to the control and to the setup menu.

ARTHUR HOLM

Albiral Display Solutions SL · Fàtima, 25 Sant Hipòlit de Voltregà 08512 Barcelona, Spain · +34 938 502 376 · marketing@arthurholm.com · www.arthurholm.com
 Arthur Holm is a registered brand of Albiral Display Solutions SL. Specifications subject to change without previous notice.

Technology serving Design

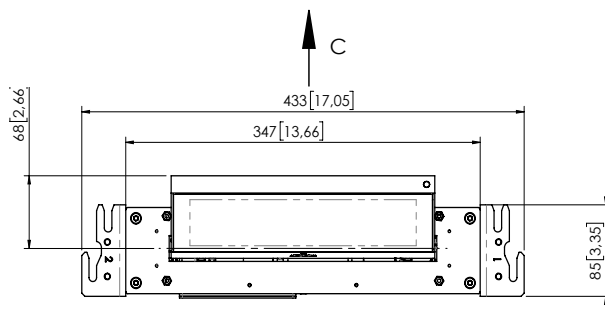
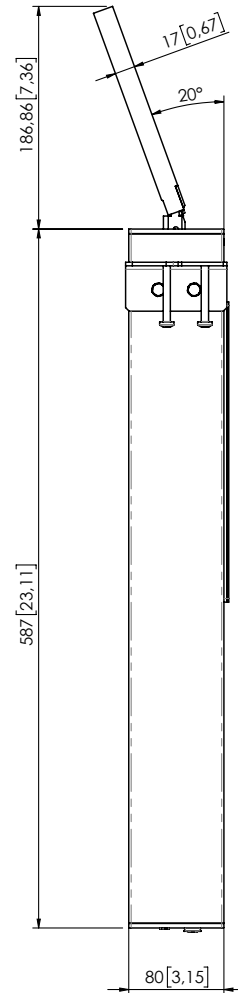
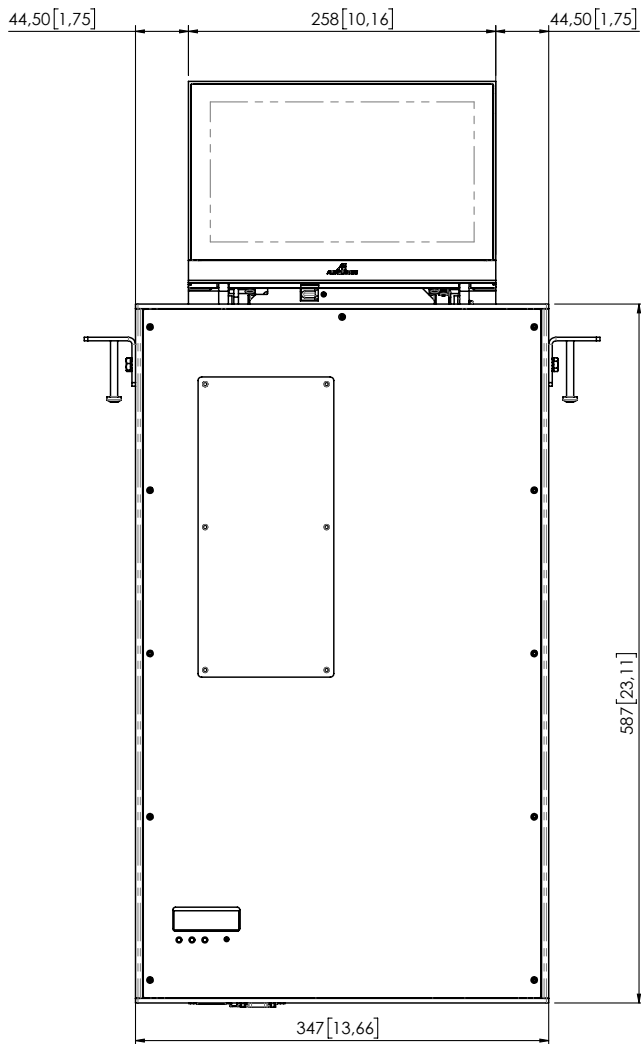

VIEW C

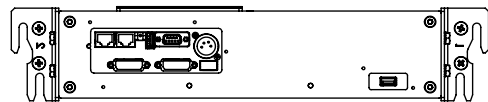

ARTHUR HOLM

Albiral Display Solutions SL · Fàtima, 25 Sant Hipòlit de Voltregà 08512 Barcelona, Spain · +34 938 502 376 · marketing@arthurholm.com · www.arthurholm.com
 Arthur Holm is a registered brand of Albiral Display Solutions SL. Specifications subject to change without previous notice.

Technology serving Design