



ARTHUR HOLM

AH17DX2KM

DynamicX2KM

HDCP compliant aluminium retractable motorised monitor

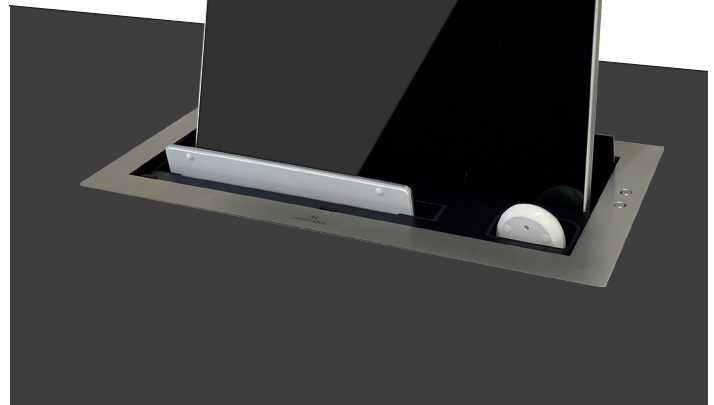
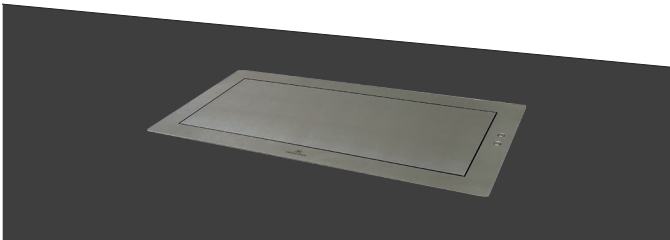
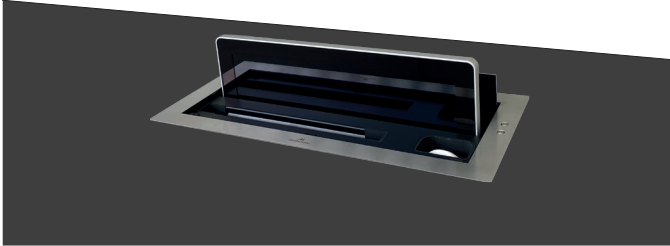

FEATURES

- Vertical motorised monitor with up to 20° inclination
- Patented single engine mechanism for up/down and tilt movements
- Synchronised lift system to raise and retract a keyboard and mouse compartment
- Milled aluminium monitor with anti-reflective front glass
- Active stainless steel customisable cover plate
- Interactive Setup Display (ISD)
- Maintenance free
- HDCP compliant
- Energy saving design, low consumption video controller
- Serial control and remote diagnosis
- Wireless connectivity for setup and control
- Individual monitor addressing
- Auto Mechanical Movement Calibration (AH-AMMC)

GENERAL

Arthur Holm DynamicX2KM is a motorised retractable monitor with an integrated lifting system for storing a standard wired or wireless keyboard and mouse. It is an HDCP compliant aluminium retractable monitor with a synchronised motorised keyboard and mouse compartment for an ideal and space optimised workstation. Easy to integrate, this compact solution allows the elevation and retraction of an elegant monitor together with a compartment that allows access to a keyboard and mouse. All can be hidden when not in use inside the furniture, allowing a neat desk free of any intrusive technology. The monitor, keyboard and mouse are hidden underneath a stainless steel cover plate that opens up and slides down inside the furniture, allowing the monitor to rise and to incline 20 degrees for a perfect viewing angle.

The movement is based on a patented mechanical system. The keyboard and mouse are raised simultaneously with the monitor to a position where the user can easily access and place them in a comfortable working position. After use, the keyboard and mouse can be placed back in this compartment where they will disappear under the stainless steel cover plate together with the monitor, leaving the desk neat and free of any obtrusive device.

ARTHUR HOLM

Albiral Display Solutions SL · Fàtima, 25 Sant Hipòlit de Voltregà 08512 Barcelona, Spain · +34 938 502 376 · marketing@arthurholm.com · www.arthurholm.com
Arthur Holm is a registered brand of Albiral Display Solutions SL. Specifications subject to change without previous notice.

Technology serving Design

Display

Size	FULL HD 17.3" TFT Active Matrix, widescreen format. LED backlight
Resolution	1920 (h) x 1080 (v)
Brightness	400 cd/m2
Contrast ratio	600:1
Pixel	0.1989 (h) x 0.1989 (v) mm
Viewing angle	60°/80°(u/d) 80°/80°(l/r)
Viewing area	381.888 (h) x 214.812 (v) mm
LED backlight lifespan	50,000 hrs
Response time	Tr 37ms, Tf 3 ms
Temperature (operating/storage)	Operating 0°C ~+40°C Storage -20°C ~+60°C

Materials

Monitor housing	Anodised Aluminium
Glass	AR 2-side with an anti-reflective coating on the glass surface. Thickness: 3.0 ± 0.3 mm
Cover plate	Stainless steel

Connectivity

Input signal	DVI-I (1 input) – HDCP Compliant - Digital / Analog DVI-D (1 input) – HDCP Compliant - Digital
RJ45 CAT6 (with loop)	Addressable RS422 monitor control by AHnet protocol
GPI (SubD9)	Up/Down control
USB	For service

Accessories

ERT	Ethernet Interface Unit
-----	-------------------------

Control

RJ45, RS-422 (I/O), AHNet protocol	
Addressing	
Termination switch	
GPI	
IR Remote control (monitor adjustments): 1/5	

Movement's Control

User interface on monitor	(Up/Down) Buttons on cover plate
Remote	RS-422 I/O, GPI

Electrical

External power supply	100-240 Vac, 47/63Hz, 12Vdc
Power consumption	60W

Mechanical

Monitor Dimensions:	
Screen	443 x 258 x 25 mm [17.44" x 10.16" x 0.98"]
Upper cover plate	540 x 95 x 3 mm [21.26" x 3.74" x 0.12"]
Housing below the table	525 x 590 x 80 mm [20.66" x 23.22" x 3.15"]
Weight	19.1 Kg / 42.1 Lbs

Automated Keyboard and Mouse compartment dimensions

Max. Keyboard dimensions	285 x 120 x 15 mm [11,22" x 4,72" x 0,52"]
Max. Mouse dimensions	120 x 65 x 40 mm [4,72" x 2,56" x 1,57"]

Shipping Dimensions:

Weight	20.1 Kg / 44.3 Lbs
Shipping Box	635 x 185 x 725 mm [25" x 7.2" x 28.54"]

OPTIONS

- Laser engraved logo
- UnderCover for veneer
- Projected capacitive multi-touch screen
- UnderCover stainless steel
- Touch sensor for UnderCover

CERTIFICATIONS

- CE
- FCC
- IECCE

WARRANTY

- 5 years limited warranty
- 2 years general warranty

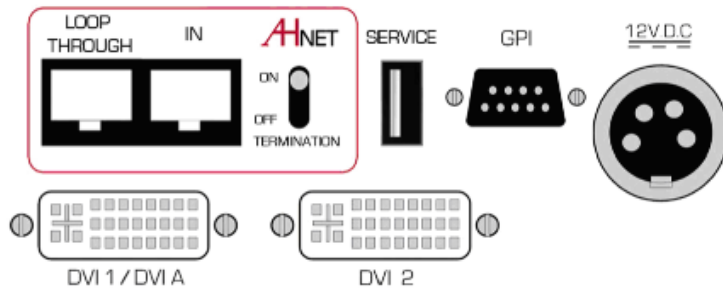

INTERACTIVE SETUP DISPLAY (ISD)

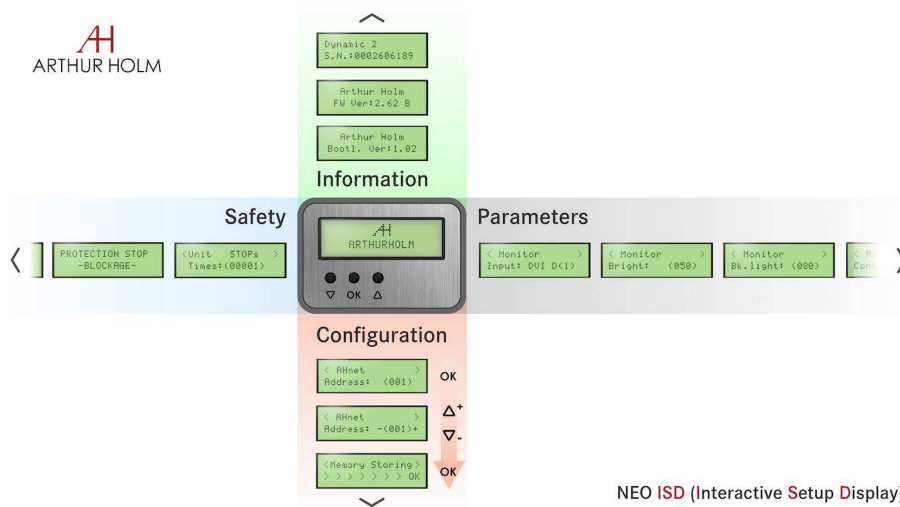

NEO ISD (Interactive Setup Display)

CONSULTANTS, ARCHITECTS AND ENGINEERS SPECIFICATIONS

Vertically retractable motorised 17,3" Full HD professional monitor. It shall include a lifting and retracting mechanism to allow the lifting and storage of wired or wireless keyboard and mouse. The cover plate shall be made of stainless steel and shall be actively activated by 2 push buttons or remotely. The cover plate shall slide down inside the furniture. The monitor housing shall be made of milled anodised aluminium and the screen shall be protected with anti-reflective 2 side coating black edged 3 mm glass. The monitor shall make the up/down and tilt movements with only one engine. The monitor shall have a brightness of the monitor shall have a brightness of 400 cd/m2, a contrast ratio of 600:1 and a backlight lifespan of 50,000 hours. The monitor shall provide 2 DVI HDCP inputs by a licensed HDCP monitor manufacturer.

The monitor shall provide an addressable RS-422 and an easy to read Interactive Setup Display (ISD) to access the safety parameters, the setup of the speeds and the control of the brightness, contract and backlight. The monitor shall be able to run an autoadjustment program to reset the factory setups. The monitor shall provide a USB port for firmware upgrades. The monitor shall be controlled by a wireless Android and iOS app providing information about the monitor’s serial number, and providing access to the control and to the setup menu.

ARTHUR HOLM

Albiral Display Solutions SL · Fàtima, 25 Sant Hipòlit de Voltregà 08512 Barcelona, Spain · +34 938 502 376 · marketing@arthurholm.com · www.arthurholm.com
 Arthur Holm is a registered brand of Albiral Display Solutions SL. Specifications subject to change without previous notice.

Technology serving Design

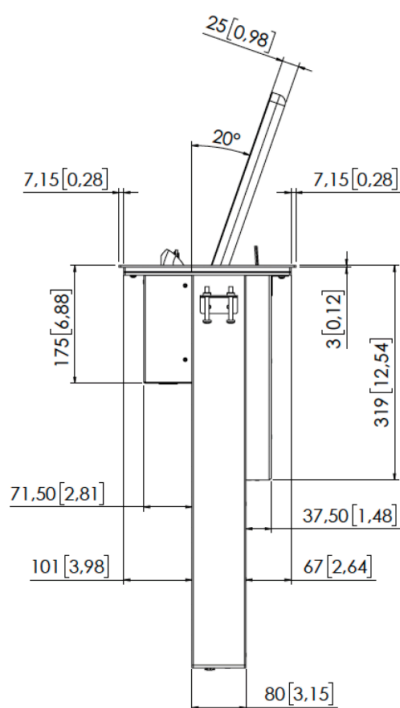
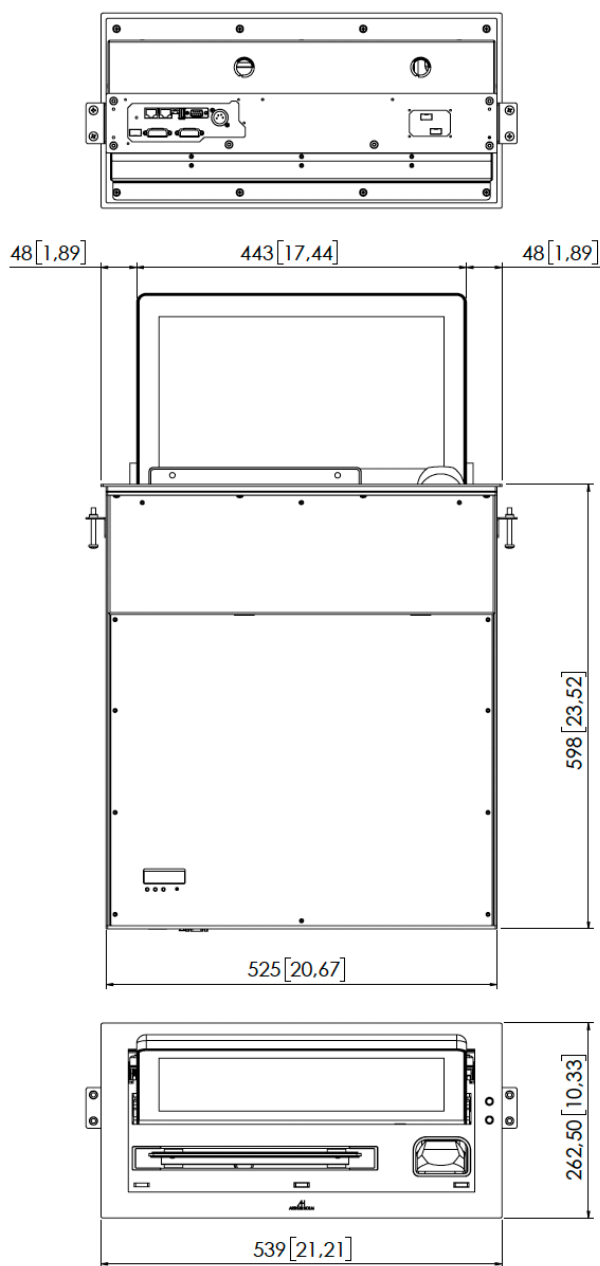

DynamicX2KM is designed to be equipped with standard Arthur Holm Keyboard/Mouse. If another Keyboard/Mouse is required, this should comply with the specifications below. If so, can be adapted for the chosen Keyboard/Mouse

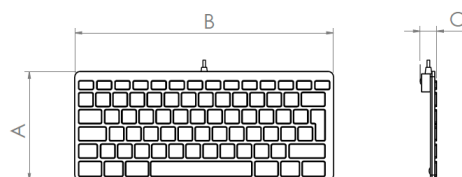

Keyboard dimension.			
Model	"A" Dimension	"B" Dimension	"C" Dimension
DX2KM FHD 17"	From 120 [4,72] to 135 [5,32]	From 270 [10,63] to 320 [12,59]	From 10 [0,39] to 25 [0,98]

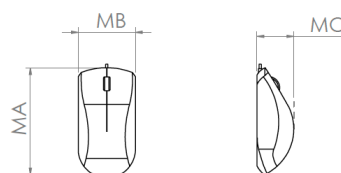

Mouse dimension.			
Model	"MA" Dimension	"MB" Dimension	"MC" Dimension
DX2KM FHD 17"	From 105 [4,13] to 120 [4,72]	From 58 [2,28] to 65 [2,54]	From 17 [0,67] to 42 [1,65]