

## CourtesyBox

Motorized housing for bottles and glasses

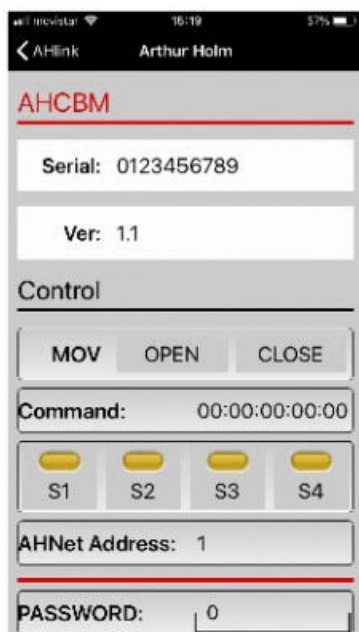
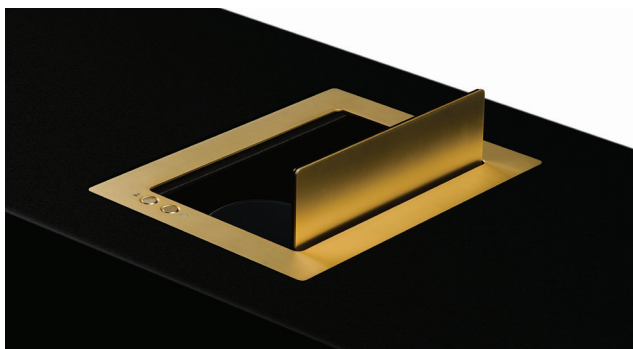
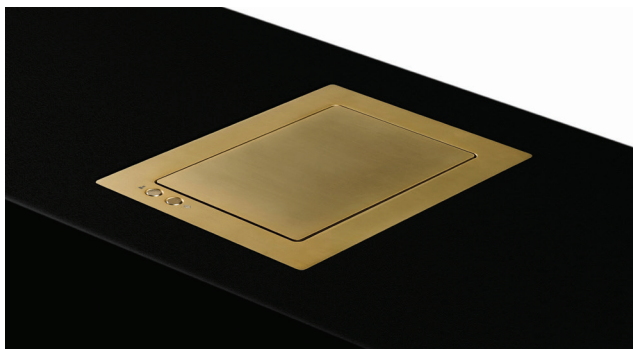

### Highlights

- Motorized housing to keep any object
- Can be veneered
- Maintenance free
- Personalized finish
- Control buttons on cover plate
- Easy installation
- Compact, space optimising and elegant solution
- Silent, reliable and durable solution
- Serial control and remote diagnosis
- AHlink: Wireless connectivity for setup, adjustments and service

The CourtesyBox is an outstanding motorized solution to hide anything in the tables, keeping the surface clean. Expect the unexpected with the CourtesyBox for water and glasses or as a tissue box.

The CourtesyBox can be controlled locally or remotely through R422 and the open/close button can be disabled or locked. The CourtesyBox can also be daisy chained with all the rest of Arthur Holm motorized products using CAT6 cables for control.

The Courtesy Box is created to be installed in horizontal surfaces of furniture. When the hatch is closed, it leaves the desk free of any obtrusive elements.

To open the hatch and access the content of the box, just press the open/close button placed on the cover plate.

If you do not find what you are looking for, contact us and we will adapt the CourtesyBox to your needs.

## Technical Specifications

### Materials

Cabinet	Brushed stainless steel
---------	-------------------------

### Connectivity

RJ45 CAT6 (with loop)	Addressable RS422 monitor control by AHnet protocol
-----------------------	---

### Engine

Control Up/Down	Buttons on cover plate, RS422 (RJ45 CAT6)
Electronic control	PWM

### Electrical

External power supply	100-240 Vac, 47/63Hz, 12Vdc
Power consumption	10W

### Mechanical

#### Case Dimensions

Upper cover plate	212 x 160 mm [8.35" x 6.30"]
Housing below the table	196.90 x 258 x 143.60 mm [7.75" x 10.17" x 5.65"]
Weight	5.3 Kg / 11.68 lbs

#### Shipping Dimensions

Weight	6.3 Kg / 13.88 lbs
Shipping Box	300 x 250 x 365 mm

## Options

- Motorized housing coated painted in different customized colours

## Finishes

- Gold, Bronze or Black finish

## Certifications

- CE

## Warranty

- 2 years general warranty

## Connectivity Panel

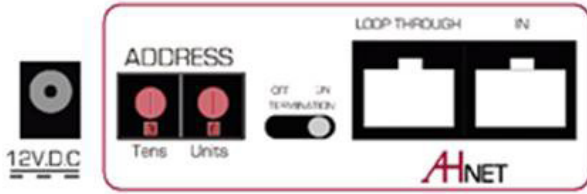

## Architect's Specifications

The CourtesyBox is a motorized brushed stainless steel box that can be controlled locally or remotely through R422 and the open/close button can be disabled or locked. The CourtesyBox can also be daisy chained with all the rest of Arthur Holm motorized products using CAT6 cables for control.

The CourtesyBox is created to be installed in horizontal surfaces of furniture. When the hatch is closed, it leaves the desk free of any obtrusive elements.

To open the hatch and access the content of the box, just press the open/close button placed on the cover plate.

General Dimensions

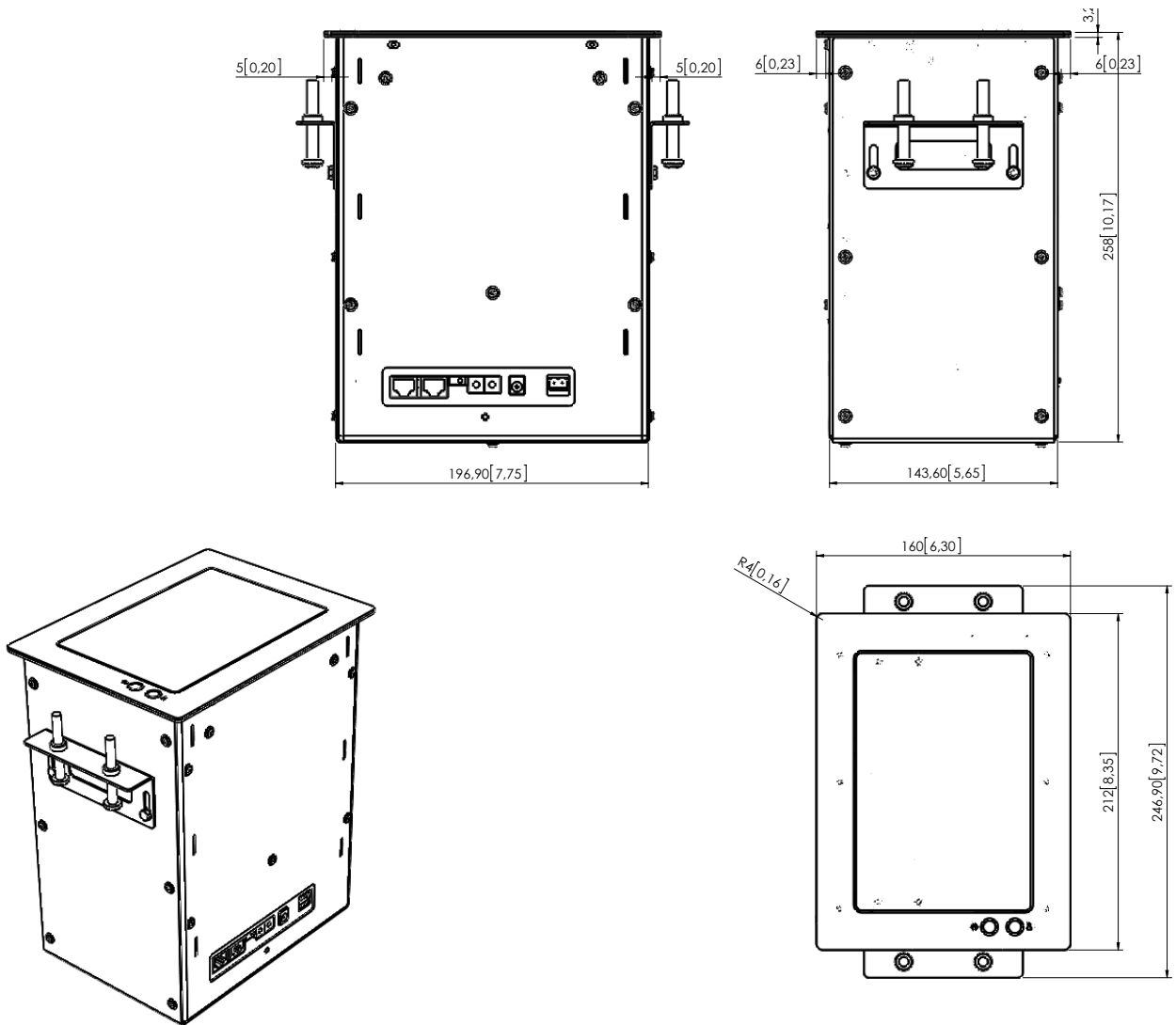

BOTTLE DIMENSIONS

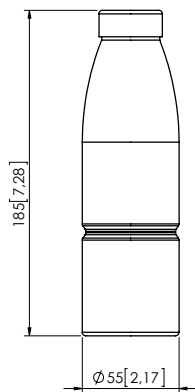

GLASS DIMENSIONS

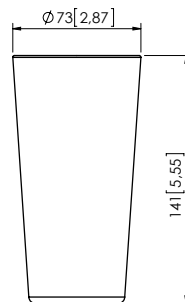

ARTHUR HOLM

Albiral Display Solutions SL · Fàtima, 25 Sant Hipòlit de Voltregà 08512 Bcelona, Spain · +34 938 502 376 · marketing@arthurholm.com  
www.arthurholm.com

Arthur Holm is a registered brand of Albiral Display Solutions SL. Specifications subject to change without previous notice.