

**DB3**

HDCP compliant aluminum motorized monitor

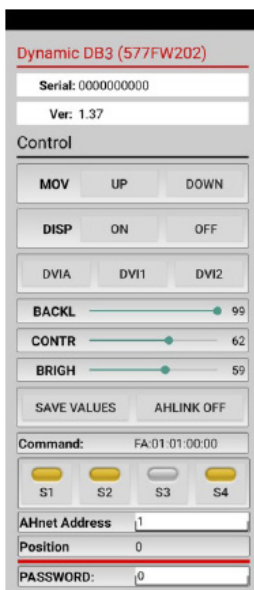

AHlink : the App for setup, control and diagnose

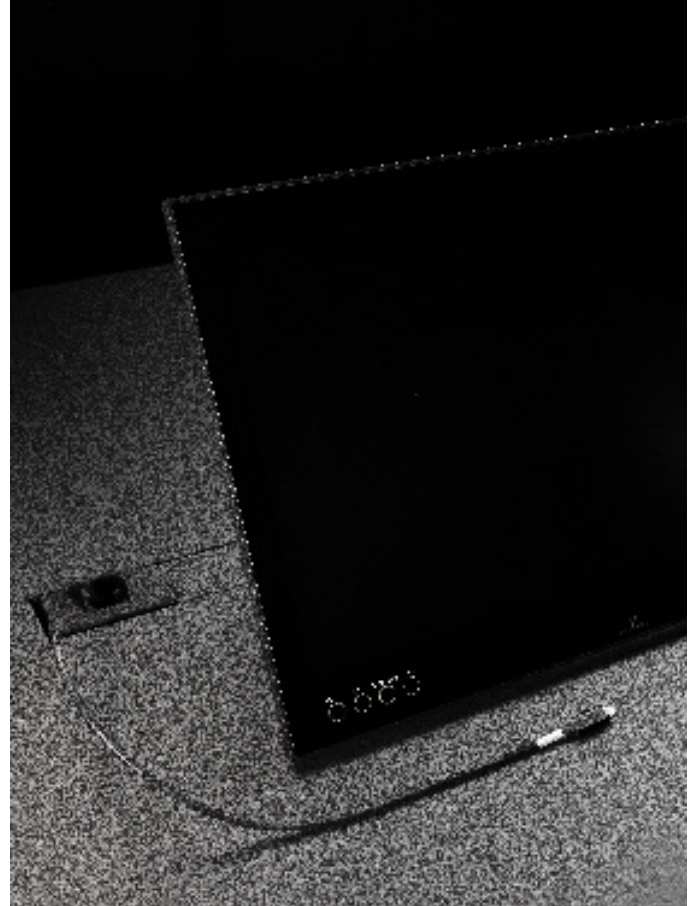

**Highlights**

- DB3 monitors with integrated DynamicShare technology
- Clean table integration with retractable cable solution
- Closed-loop HDMI distribution integrated inside the table
- Plug-and-play operation (no adapters, no compatibility issues, no software needed, no IT support)
- Wired presentation system with retractable HDMI cable (optional USB-C)
- One-touch content selection (View) and sharing (Share) for instant meeting start
- Maximum security (no wireless transmission)
- Input selection: up to 3 HDMI sources
- Output distribution: share to up to 20 displays simultaneously

## General Description

### Smart Communication, Invisible Integration.

**A discreet, all-in-one solution for smarter, more collaborative meetings.**

DB3Share is a wired presentation system that enables users to connect their laptop directly to a monitor via a retractable HDMI cable (optional USB-C) and start sharing content instantly by simply touching a button, ensuring maximum security with no wireless transmission. It consists in DB3 monitors featuring the DynamicShare system and a retractable cable.

This solution eliminates common meeting friction—no adapters, no compatibility issues, no software installation, and no IT support required—allowing meetings to start faster and run more smoothly with a reliable, plug-and-play experience.

Users can select between up to 3 HDMI inputs and distribute the chosen content to up to 20 displays simultaneously, making it ideal for multi-screen environments such as boardrooms, auditoriums, or training spaces.

To share the contents to a wall display, a DynamicShare StandAlone should be added to the system.

## Options and accessories

- Built-in DynamicTalk
- Projected capacitive multi-touch screen
- Retractable USBC cable
- Integrated USB camera
- Automated hatch ready for veneering with capacitive sensor
- ERT-30 / ERT-60

## Warranty

- 2 years general warranty

## Certifications

- CE
- IECEE
- CB
- RoHS

## Connectivity Panel

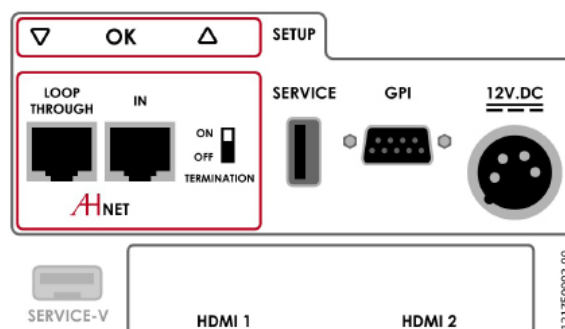

ARTHUR HOLM

Albiral Display Solutions SL · Fàtima, 25 · 08512 Sant Hipòlit de Voltregà · Barcelona, Spain · +34 938 502 376 · marketing@arthurholm.com · www.arthurholm.com  
Arthur Holm is a registered brand of Albiral Display Solutions SL. Specifications subject to change without previous notice.

MakeYourMeetingsCount

## Technical Specifications

### Display

Size	Full HD 17.3" TFT Active Matrix, widescreen format. LED backlight
Resolution	1920 (h) x 1080 (v)
Brightness	480 cd/m2
Contrast ratio	1100:1
Pixel	0.1989 (h) x 0.1989 (v) m
Viewing angle	85° / 85° (l/r) 85° / 85° (u/d)
Viewing area	389.888 (h) x 227.612 (v) mm
Response time	Tr + Tf 16 ms
Temperature	Operating 0°C ~ +40°C Storage -20°C ~ +60°C

### Materials

Monitor housing	Solid mechanized aluminum housing with black anodized finish. Front black serigraphed glass
-----------------	---

### Connectivity

Input signal	3 local HDMI - HDCP compliant
Dynamic Share Signal	2 HDMI - loop in/loop out
RJ45 CAT6 FTP (with loop)	Addressable RS-422/RS-485 Full Duplex control by AHnet protocol
GPI (SubD9)	Up/Down control (opto isolated)
USB	For service (firmware upgrades)

### Control

RJ45, RS-422/RS-485 Full Duplex(I/O), AHnet protocol
AHlink
Addressing
Termination switch
GPI
IR Remote control (monitor adjustments): 1 remote control is provided every 5 motorized devices
Interactive Setup Display

### Movement's Control

User interface on monitor	(Up/Down/Close) Capacitive touch sensor
Remote	RS-422/RS-485 Full Duplex (I/O), GPI
AHlink	

### Electrical

External power supply	100-240 Vac, 50/60Hz, 12Vdc
Power consumption	70W

### Accessories

ERT-30 / ERT-60	Ethernet Interface Unit
-----------------	-------------------------

### Mechanical

Screen	414 x 40 x 289.38 mm [16.30" x 1.57" x 11.39"]
Top frame	516 x 43 mm [20.31" x 1.69"]
Housing below the table	588 x 145.5 x 601 mm [23.15" x 5.73" x 23.66"]
Weight	23.4Kg / 51.59 Lbs approx.

### Packaging information

Packaging Dimensions	685 x 265 x 765mm
Weight	24.4kg / 53.79 Lbs approx.

## Interactive Setup Display (ISD)

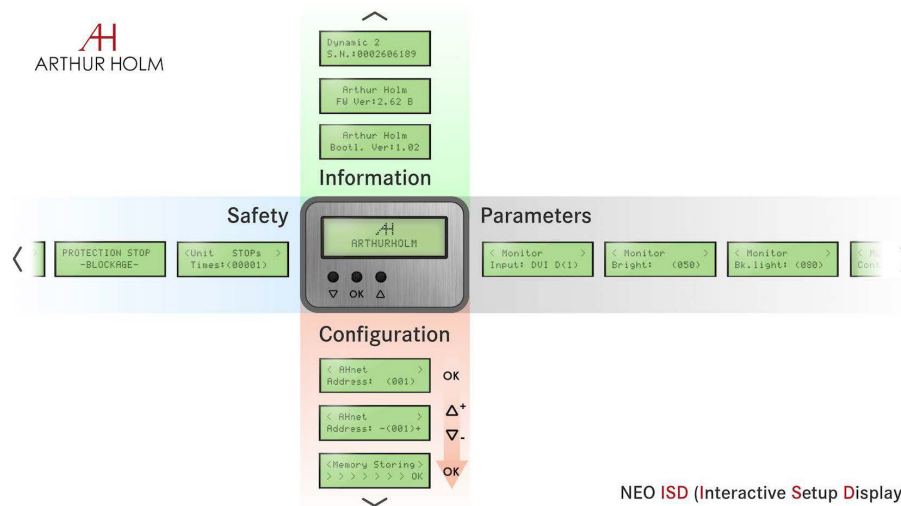

### Consultants, architects and engineers specifications

The system shall consist of a vertically retractable monitor of 17 inches, featuring a native Full HD resolution (1920 × 1080). The monitor shall provide a motorized adjustable inclination from 90° to 20° relative to the table surface, including a position memory function.

The display shall have a minimum brightness of 480 cd/m<sup>2</sup> and a contrast ratio of 1100:1, ensuring optimal visibility under typical meeting room lighting conditions.

The solution shall incorporate a retractable HDMI cable, deployable through a capacitive touch button integrated on the glass surface. The monitor shall include two (2) HDCP-compliant HDMI inputs located at the bottom of the unit.

The monitor shall feature integrated capacitive touch controls positioned below the active display area, enabling users to:

- Select between available inputs (View function)
- Share the selected signal (Share function)

The system shall support HDMI daisy-chain distribution, allowing connection of up to 20 monitors at Full HD resolution without signal degradation.

# General Dimensions

# AH17DB3Share

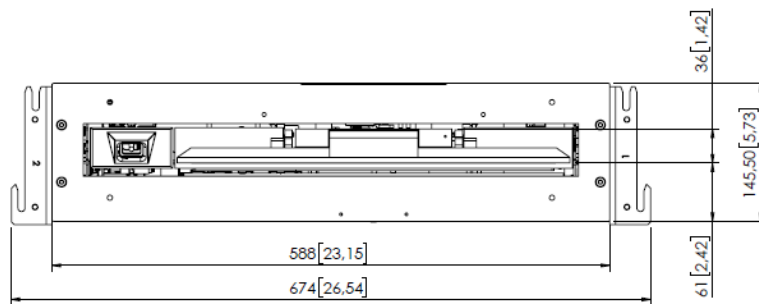
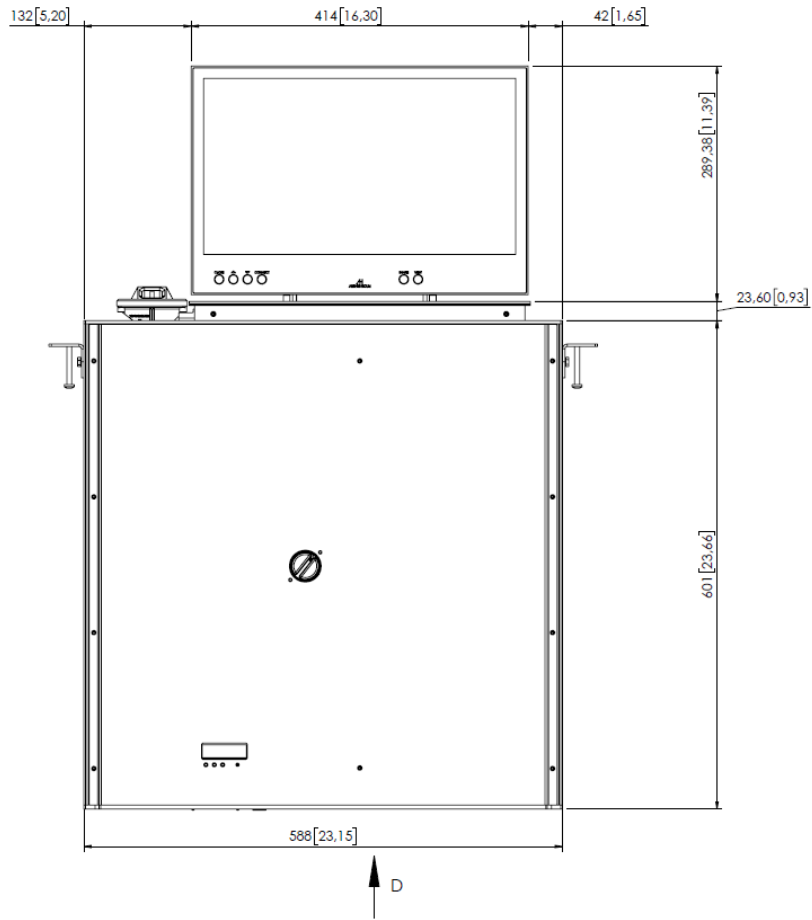

ARTHUR HOLM

Albiral Display Solutions SL · Fàtima, 25 · 08512 Sant Hipòlit de Voltregà · Barcelona, Spain · +34 938 502 376 · marketing@arthurholm.com · www.arthurholm.com  
Arthur Holm is a registered brand of Albiral Display Solutions SL. Specifications subject to change without previous notice.

MakeYourMeetingsCount

## General Dimensions

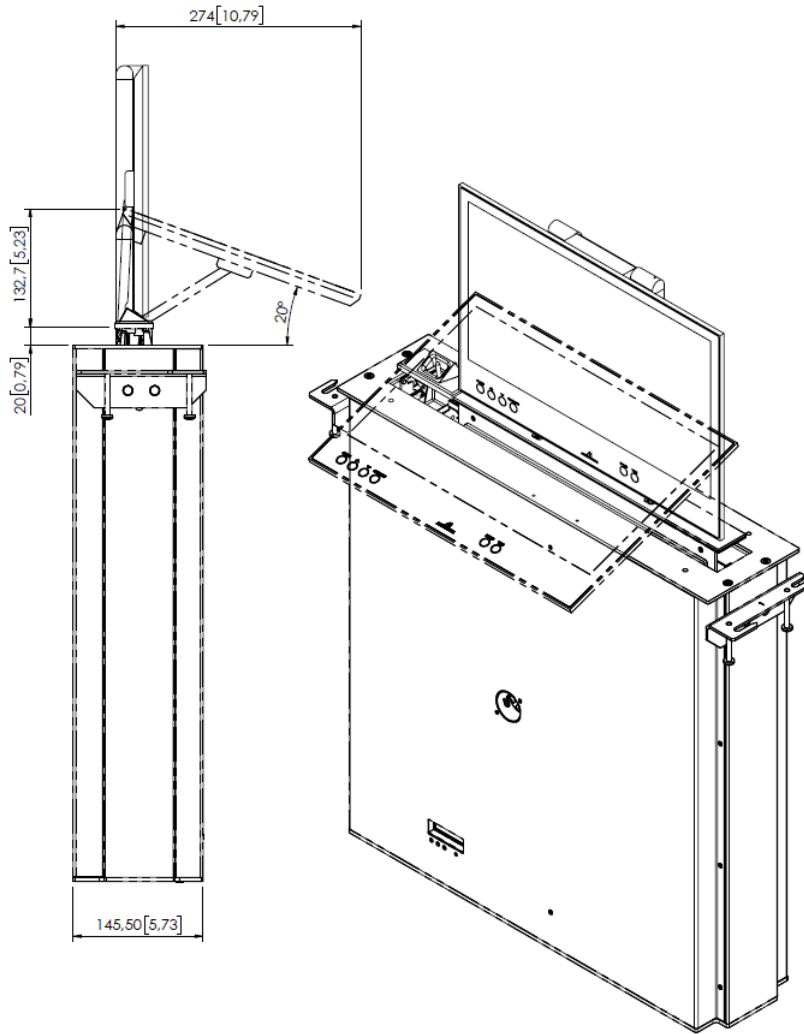

VIEW D

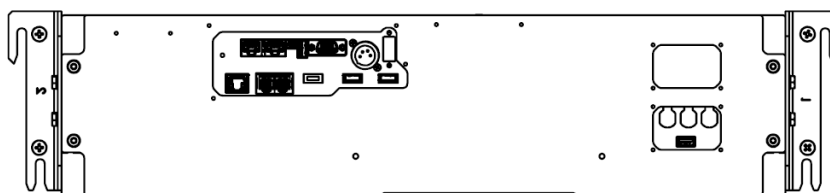

ARTHUR HOLM

Albiral Display Solutions SL · Fàtima, 25 · 08512 Sant Hipòlit de Voltregà · Barcelona, Spain · +34 938 502 376 · marketing@arthurholm.com · www.arthurholm.com  
Arthur Holm is a registered brand of Albiral Display Solutions SL. Specifications subject to change without previous notice.

MakeYourMeetingsCount

## DB3Share Connection Diagram

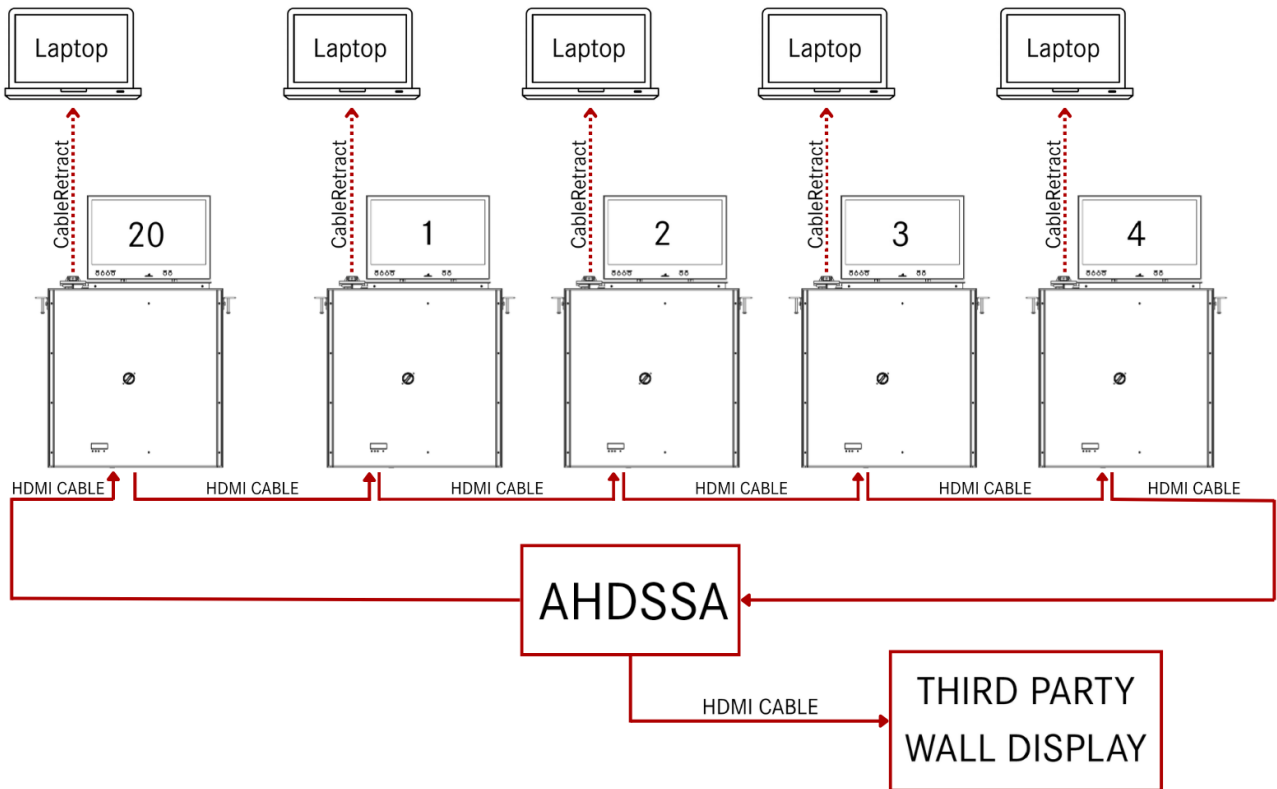

ARTHUR HOLM

Albiral Display Solutions SL · Fàtima, 25 · 08512 Sant Hipòlit de Voltregà · Barcelona, Spain · +34 938 502 376 · marketing@arthurholm.com · www.arthurholm.com  
Arthur Holm is a registered brand of Albiral Display Solutions SL. Specifications subject to change without previous notice.

MakeYourMeetingsCount