

## DynamicSpeaker

Motorized loudspeaker for desk integration

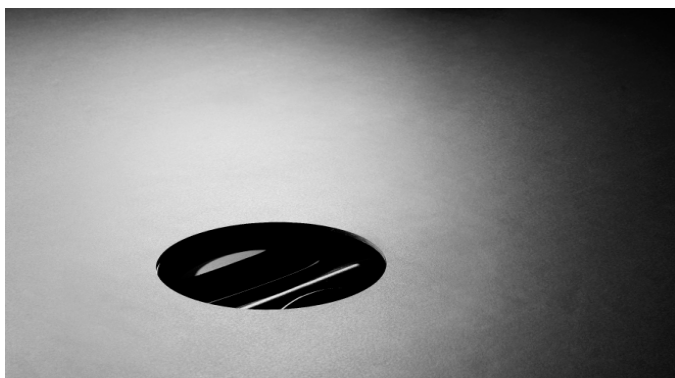
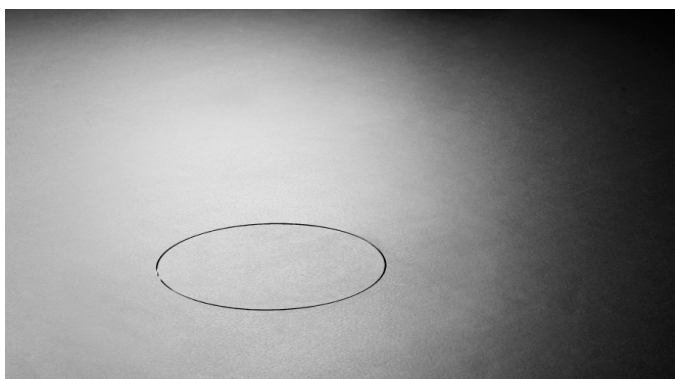

DynamicSpeaker\_UI: prepared for veneer

### Highlights

- Natural sound direction
- Speech intelligibility
- High gain before feedback
- Close proximity to user
- Limited audio pollution
- 360 degrees loudspeaker
- 4" 2-Way coaxial speaker, bass reflex
- 2 x 36W class-D integrated bi-amplifier
- Acoustic omnidirectional diffuser
- DSP integrated Balanced line input
- RS-422/RS-485 Full Duplex controllable
- Near field audio reproduction
- Speech intelligibility enhancement
- Wooden speaker enclosure
- Auto Mechanical Movement Calibration (AH-AMMC)
- Compatible with wireless connectivity for setup and control via AHlink when used in combination with an installed ERT.

### ARTHUR HOLM

Albiral Display Solutions SL · Fàtima, 25 · 08512 Sant Hipòlit de Voltregà · Barcelona, Spain · +34 938 502 376 · marketing@arthurholm.com · www.arthurholm.com  
Arthur Holm is a registered brand of Albiral Display Solutions SL. Specifications subject to change without previous notice.

**Make Your Meetings Count!**

## General

Arthur Holm DynamicSpeaker is a motorized loudspeaker for desk and furniture integration that brings flexibility and impressive audio quality with enhanced speech intelligibility to the meeting room or other rooms where quality audio is needed.

The compact, omnidirectional 360 degrees active speaker has a twin 36W Class-D integrated amplifier and a two-way coaxial transducer that brings the audio to the dedicated area with its acoustic diffuser through its integrated DSP technology.

It can be controlled using the AHnet and it is compatible with the AHlink wireless Android and iOS App for control and setup when used in combination with an installed ERT. DynamicSpeaker is compatible with ERT-30 and ERT-60. The use of Arthur Holm's ERT will enable the address configuration of all the units installed in a table by simply pressing a button.

## Connectivity

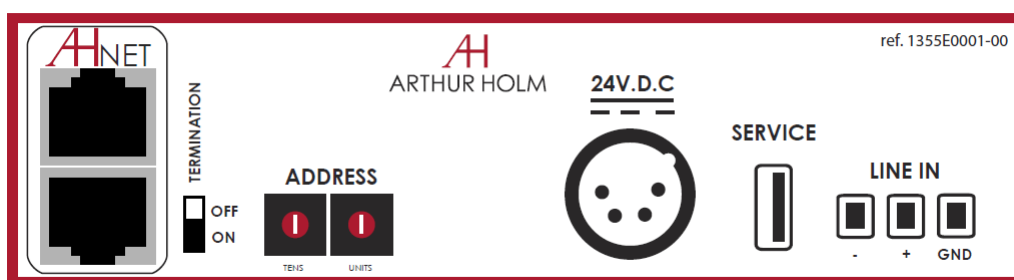

## Options

- Underneath installation
- Painted

## Warranty

- 2 years general warranty

## Certifications

- CE

## Technical Specifications

### Audio Features

4" coaxial loudspeaker
Class-D 2-way bi-amplified
RMS power 2 x 36.5W
360° dispersion
Balanced analogue audio input. Level line +4dB
Internal DSP
Frequency response: 100Hz. - 10KHz. (± 7.5 dB)
Adjustable gain through AHnet (RS-422/RS-485 Full Duplex Protocol)
Mute function through AHnet (RS-422/RS-485 Full Duplex Protocol)

### Materials

Brushed stainless steel
Steel
Aluminum
Wood

### Finishing

Speaker driver mat black
Speaker diffuser mat black, non-reflecting
Cover plate in brushed stainless steel / mat black / white
Black housing

### Connectivity

USB Port for software update
XLR-4 DC input

### Engine

Control Up/Down	Capacitive touch button on cover plate
	Touch sensor (for the veneered option)
RJ45 CAT6	Addressable RS-422/RS-485 Full Duplex control by AHnet protocol

### Electrical

External power supply	100-240 Vac, 50/60Hz. 24VdC
Power consumption	90W

### Mechanical

Case Dimensions:	
Upper cover plate	Ø 254 x 3 mm [10.00" x 0.11"]
Housing below the table	Ø 251 x 211 mm [9.88" x 8.31"]
Weight	8 Kg / 17.63 Lbs

## Consultants, architects and engineers specifications

The retractable motorized loudspeaker shall provide an active loudspeaker, which shall be two-way in-surface system consisting of a 4" coaxial omnidirectional transducer mounted in a wooden ported enclosure with 2 36W class-D bi-amplifier and DSP technology integrated, omnidirectional acoustic diffuser. The cover plate shall be made of stainless steel.

The input connection shall be made via a 4-pin lockable XLR connector (DC), 2 E45 connectors with loop-through, 2 USB and PCB block connectors. The dispersion shall be 360° up to 10kHz. The on-axis frequency response shall be 100Hz-10kHz +/- 7dB and the loud-speaker shall produce a maximum SPL of 105dB peak measured at 1 meter. Power handling shall be 74W AES, 104W peak. The loudspeaker shall be equipped with two rotary switches for selection of address and set-ups, and 2 x USB ports for firmware upgrades.

The mechanical movement shall be made using only one engine and a combination of a linear and circular movement shall move the transducer enclosure down, rotate it and lift the transducer and the acoustic diffuser so the transducer is at level with the housing surface.

The DynamicSpeaker shall be equipped with an Auto Mechanical Calibration Movement System (AH-AMMC). The use of the Arthur Holm's ERT will enable the address configuration of all the monitors installed in a table by simply pressing a button. The unit shall be compatible with AHlink Android and iOS app which allows access to the setup, diagnose and control menus.

### ARTHUR HOLM

Albiral Display Solutions SL · Fàtima, 25 · 08512 Sant Hipòlit de Voltregà · Barcelona, Spain · +34 938 502 376 · marketing@arthurholm.com · www.arthurholm.com  
Arthur Holm is a registered brand of Albiral Display Solutions SL. Specifications subject to change without previous notice.

Make Your Meetings Count!

## Frequency Response

All measurements are taken with the speaker installed in a 1 m x 1 m wooden surface

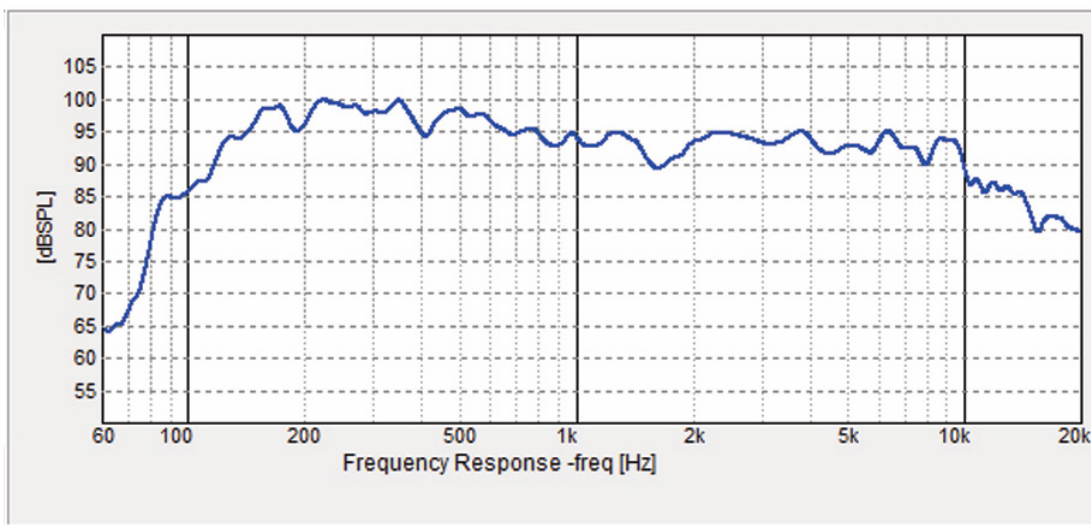

## POLAR PATTERNS

### HORIZONTAL

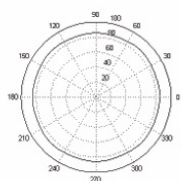

1 kHz

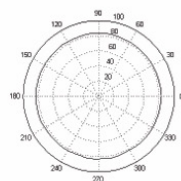

2 kHz

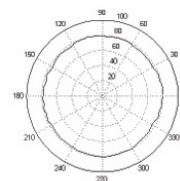

4 kHz

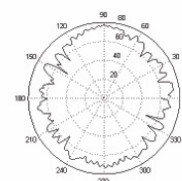

8 kHz

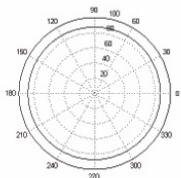

125 kHz

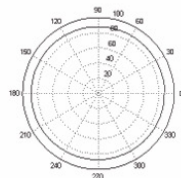

250 kHz

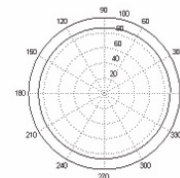

500 kHz

### VERTICAL



1 kHz

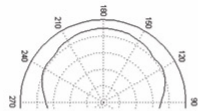

2 kHz

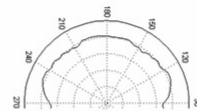

4 kHz

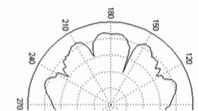

8 kHz

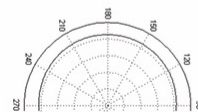

125 kHz

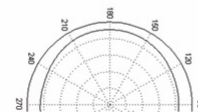

250 kHz

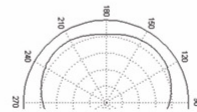

500 kHz

ARTHUR HOLM

Albiral Display Solutions SL · Fàtima, 25 · 08512 Sant Hipòlit de Voltregà · Barcelona, Spain · +34 938 502 376 · marketing@arthurholm.com · www.arthurholm.com  
Arthur Holm is a registered brand of Albiral Display Solutions SL. Specifications subject to change without previous notice.

Make Your Meetings Count!

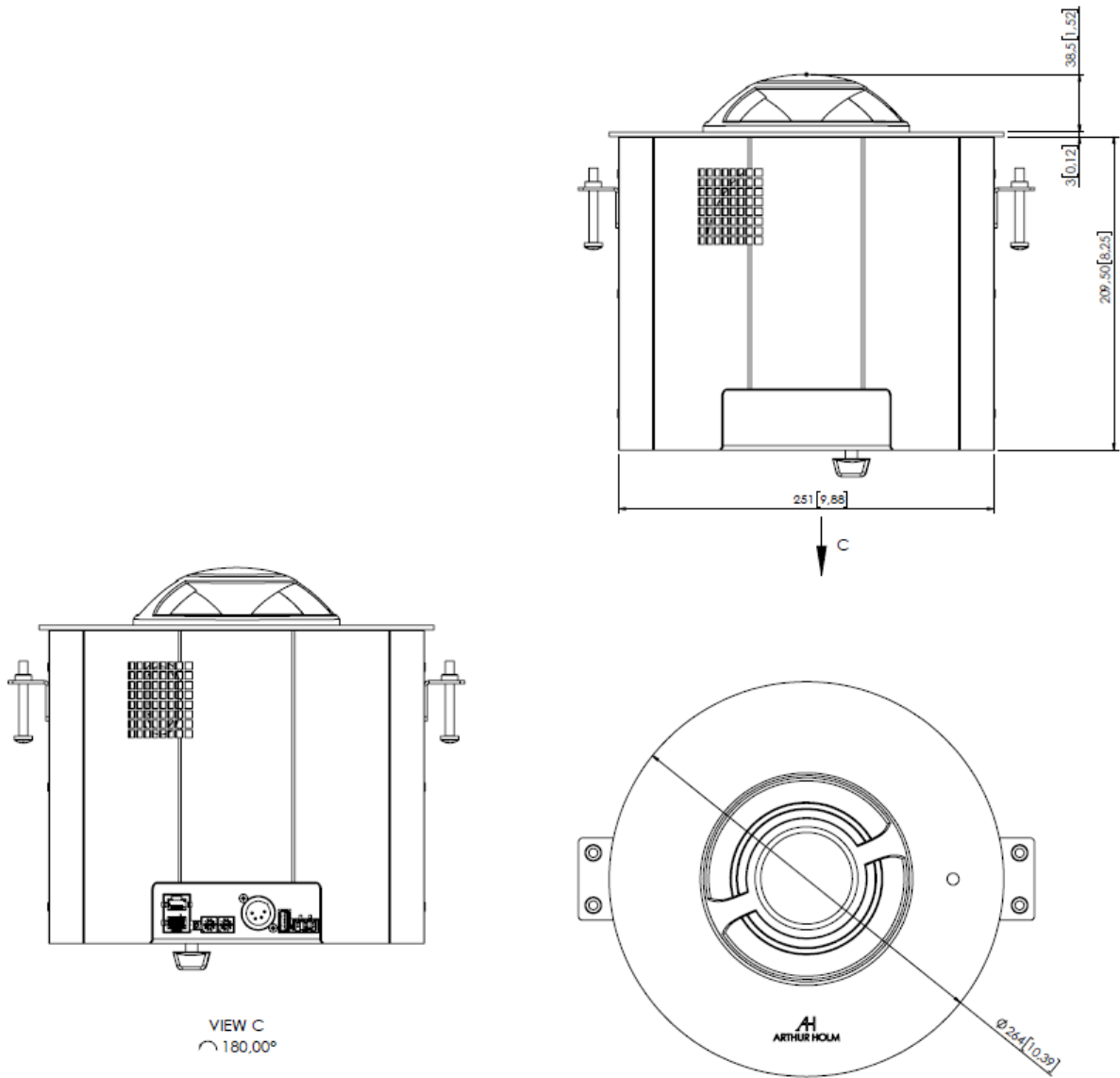

VIEW C  
 $\curvearrowright$  180.00°

ARTHUR HOLM

Albiral Display Solutions SL · Fàtima, 25 · 08512 Sant Hipòlit de Voltregà · Barcelona, Spain · +34 938 502 376 · marketing@arthurholm.com · www.arthurholm.com  
 Arthur Holm is a registered brand of Albiral Display Solutions SL. Specifications subject to change without previous notice.

Make Your Meetings Count!

Veneered Option

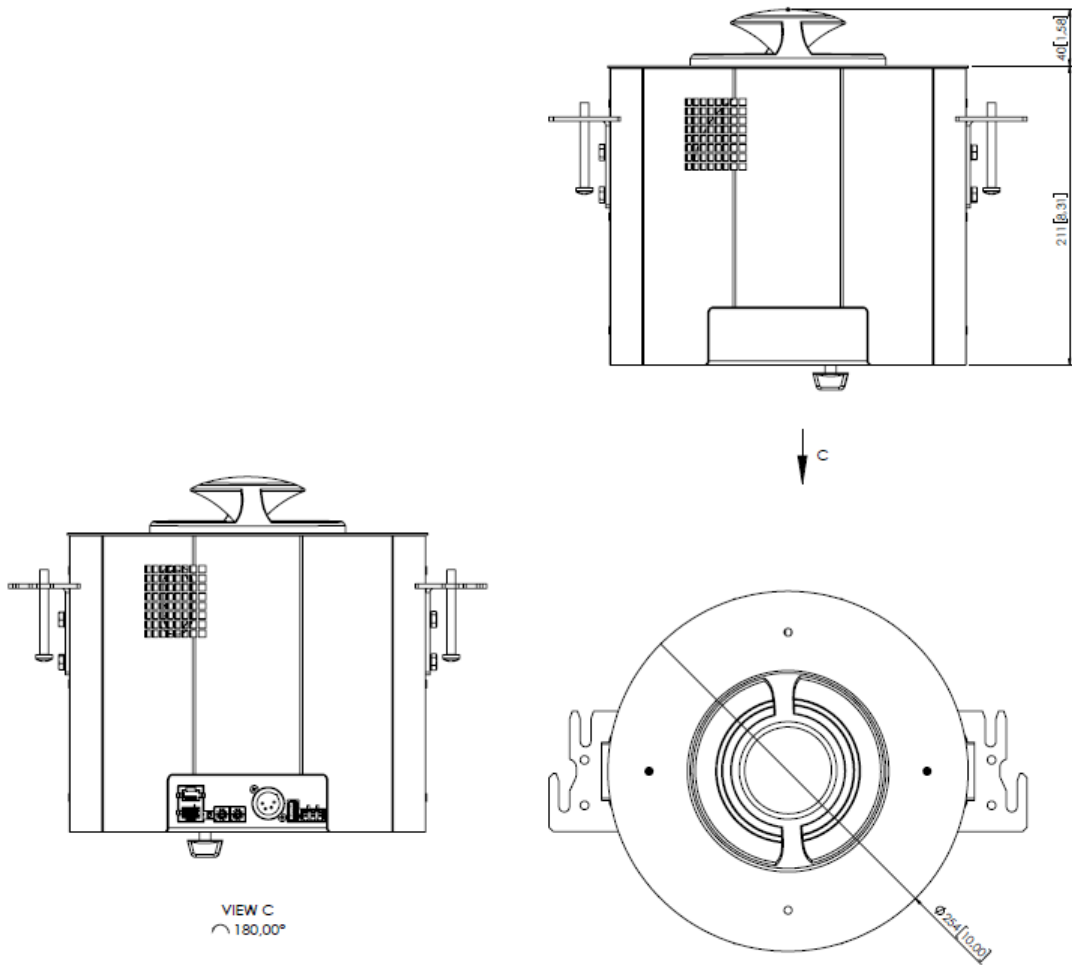

ARTHUR HOLM