

DB3

HDCP compliant aluminum motorized monitor

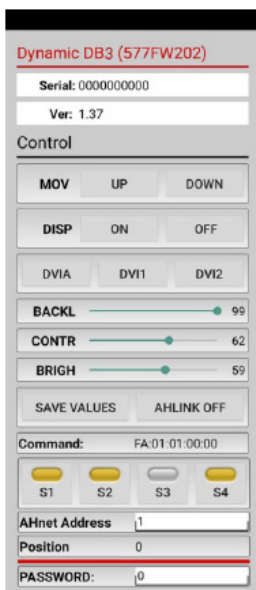

AHlink : the App for setup, control and diagnose



Highlights

- DB3 monitors with integrated DynamicShare technology
- Clean table integration with retractable cable solution
- Closed-loop HDMI distribution integrated inside the table
- Plug-and-play operation (no adapters, no compatibility issues, no software needed, no IT support)
- Wired presentation system with retractable HDMI cable (optional USB-C)
- One-touch content selection (View) and sharing (Share) for instant meeting start
- Maximum security (no wireless transmission)
- Input selection: up to 3 HDMI sources
- Output distribution: share to up to 20 displays simultaneously

General Description

Smart Communication, Invisible Integration.

A discreet, all-in-one solution for smarter, more collaborative meetings.

DB3Share is a wired presentation system that enables users to connect their laptop directly to a monitor via a retractable HDMI cable (optional USB-C) and start sharing content instantly by simply touching a button, ensuring maximum security with no wireless transmission. It consists in DB3 monitors featuring the DynamicShare system and a retractable cable.

This solution eliminates common meeting friction—no adapters, no compatibility issues, no software installation, and no IT support required—allowing meetings to start faster and run more smoothly with a reliable, plug-and-play experience.

Users can select between up to 3 HDMI inputs and distribute the chosen content to up to 20 displays simultaneously, making it ideal for multi-screen environments such as boardrooms, auditoriums, or training spaces.

To share the contents to a wall display, a DynamicShare StandAlone should be added to the system.

Options and accessories

- Built-in DynamicTalk
- Projected capacitive multi-touch screen
- Retractable USBC cable
- Integrated USB camera
- Automated hatch ready for veneering with capacitive sensor
- ERT-30 / ERT-60

Warranty

- 2 years general warranty

Certifications

- CE
- IECEE
- CB
- RoHS

Connectivity Panel

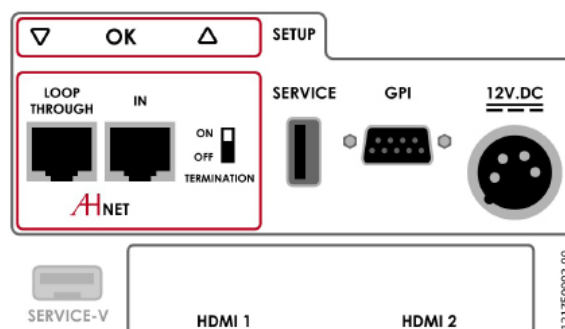

ARTHUR HOLM

Albiral Display Solutions SL · Fàtima, 25 · 08512 Sant Hipòlit de Voltregà · Barcelona, Spain · +34 938 502 376 · marketing@arthurholm.com · www.arthurholm.com
Arthur Holm is a registered brand of Albiral Display Solutions SL. Specifications subject to change without previous notice.

MakeYourMeetingsCount

Technical Specifications

Display

Size	Full HD 17.3" TFT Active Matrix, widescreen format. LED backlight
Resolution	1920 (h) x 1080 (v)
Brightness	480 cd/m2
Contrast ratio	1100:1
Pixel	0.1989 (h) x 0.1989 (v) m
Viewing angle	85° / 85° (l/r) 85° / 85° (u/d)
Viewing area	389.888 (h) x 227.612 (v) mm
Response time	Tr + Tf 16 ms
Temperature	Operating 0°C ~ +40°C Storage -20°C ~ +60°C

Materials

Monitor housing	Solid mechanized aluminum housing with black anodized finish. Front black serigraphed glass
-----------------	---

Connectivity

Input signal	3 local HDMI - HDCP compliant
Dynamic Share Signal	2 HDMI - loop in/loop out
RJ45 CAT6 FTP (with loop)	Addressable RS-422/RS-485 Full Duplex control by AHnet protocol
GPI (SubD9)	Up/Down control (opto isolated)
USB	For service (firmware upgrades)

Control

RJ45, RS-422/RS-485 Full Duplex(I/O), AHnet protocol
AHlink
Addressing
Termination switch
GPI
IR Remote control (monitor adjustments): 1 remote control is provided every 5 motorized devices
Interactive Setup Display

Movement's Control

User interface on monitor	(Up/Down/Close) Capacitive touch sensor
Remote	RS-422/RS-485 Full Duplex (I/O), GPI
AHlink	

Electrical

External power supply	100-240 Vac, 50/60Hz, 12Vdc
Power consumption	70W

Accessories

ERT-30 / ERT-60	Ethernet Interface Unit
-----------------	-------------------------

Mechanical

Screen	414 x 40 x 289.38 mm [16.30" x 1.57" x 11.39"]
Top frame	516 x 43 mm [20.31" x 1.69"]
Housing below the table	588 x 145.5 x 601 mm [23.15" x 5.73" x 23.66"]
Weight	23.4Kg / 51.59 Lbs approx.

Packaging information

Packaging Dimensions	685 x 265 x 765mm
Weight	24.4kg / 53.79 Lbs approx.

Interactive Setup Display (ISD)

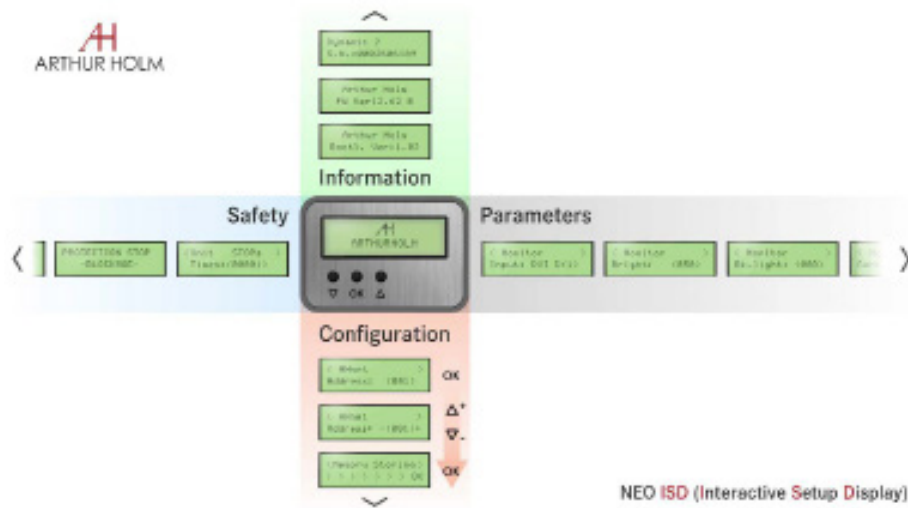

Consultants, architects and engineers specifications

The system shall consist of a vertically retractable monitor of 17 inches, featuring a native Full HD resolution (1920 × 1080). The monitor shall provide a motorized adjustable inclination from 90° to 20° relative to the table surface, including a position memory function.

The display shall have a minimum brightness of 480 cd/m² and a contrast ratio of 1100:1, ensuring optimal visibility under typical meeting room lighting conditions.

The solution shall incorporate a retractable HDMI cable, deployable through a capacitive touch button integrated on the glass surface. The monitor shall include two (2) HDCP-compliant HDMI inputs located at the bottom of the unit.

The monitor shall feature integrated capacitive touch controls positioned below the active display area, enabling users to:

- Select between available inputs (View function)
- Share the selected signal (Share function)

The system shall support HDMI daisy-chain distribution, allowing connection of up to 20 monitors at Full HD resolution without signal degradation.

General Dimensions

AH17DB3Share

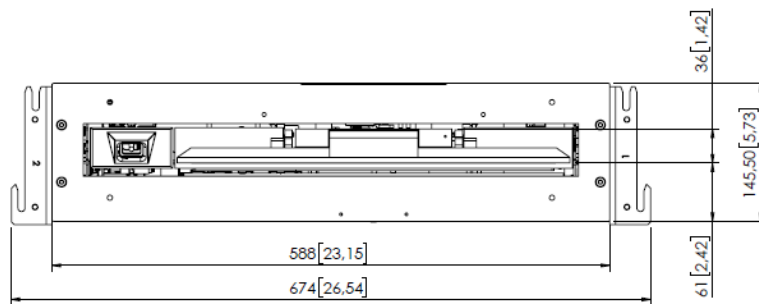
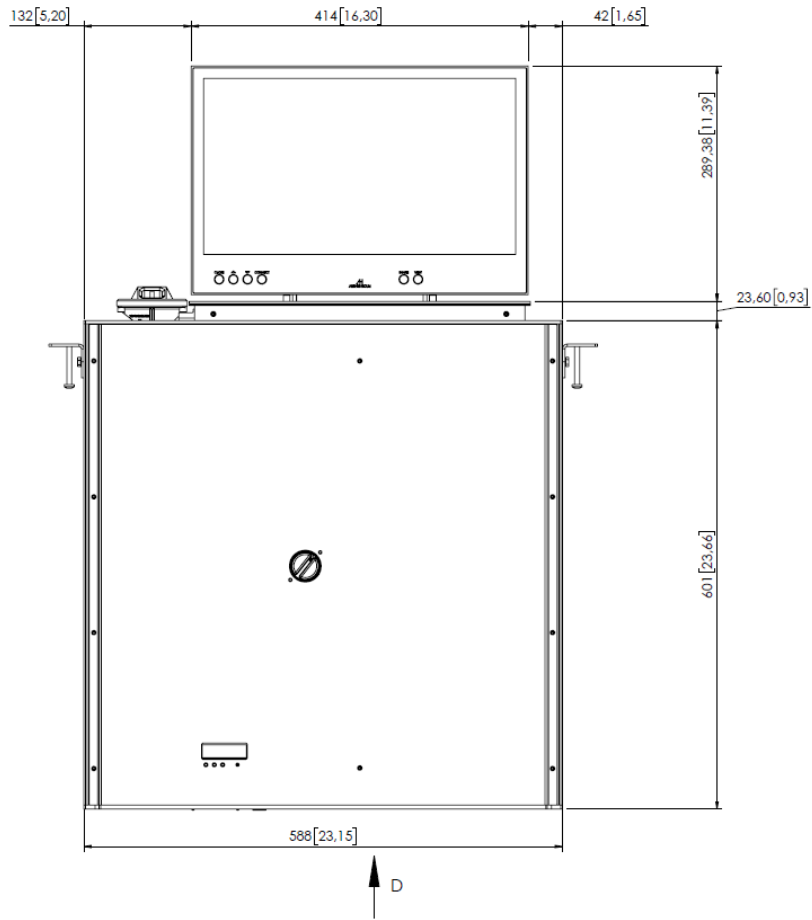

ARTHUR HOLM

Albiral Display Solutions SL · Fàtima, 25 · 08512 Sant Hipòlit de Voltregà · Barcelona, Spain · +34 938 502 376 · marketing@arthurholm.com · www.arthurholm.com
Arthur Holm is a registered brand of Albiral Display Solutions SL. Specifications subject to change without previous notice.

MakeYourMeetingsCount

General Dimensions

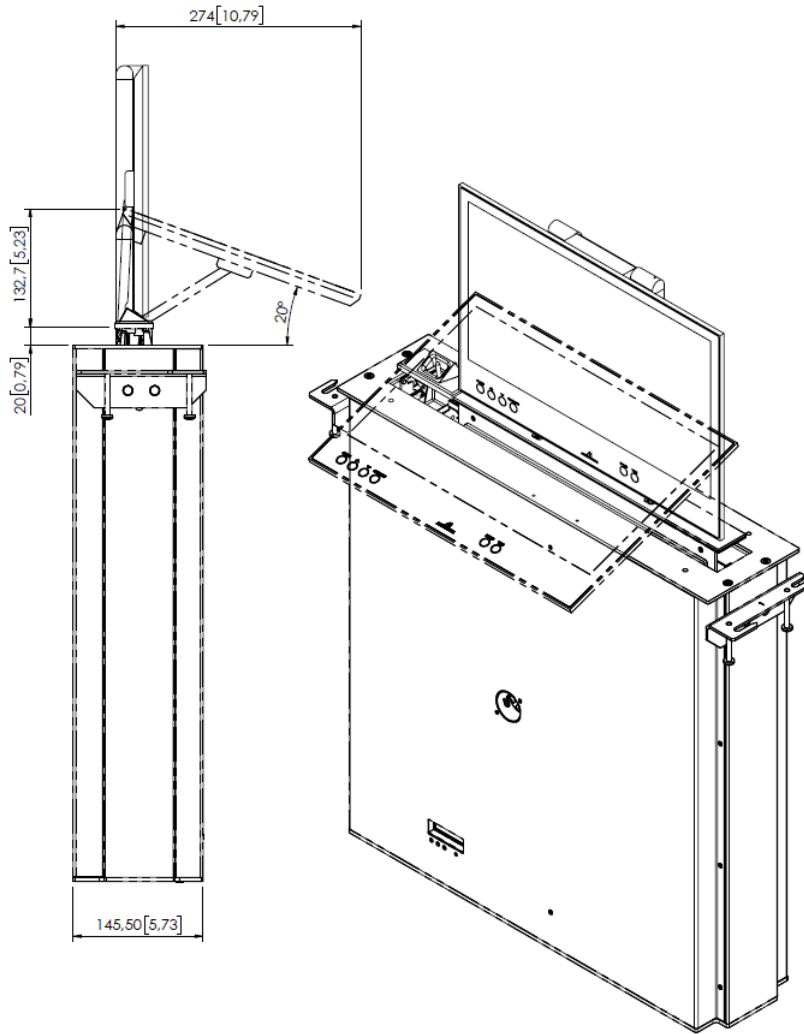

VIEW D

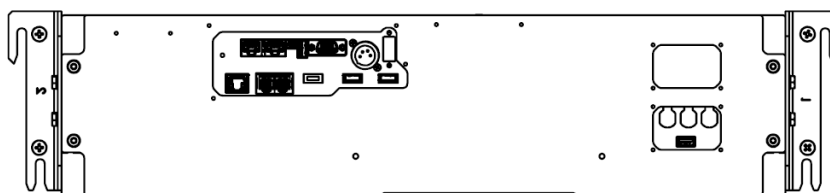

ARTHUR HOLM

Albiral Display Solutions SL · Fàtima, 25 · 08512 Sant Hipòlit de Voltregà · Barcelona, Spain · +34 938 502 376 · marketing@arthurholm.com · www.arthurholm.com
Arthur Holm is a registered brand of Albiral Display Solutions SL. Specifications subject to change without previous notice.

MakeYourMeetingsCount

DB3Share Connection Diagram

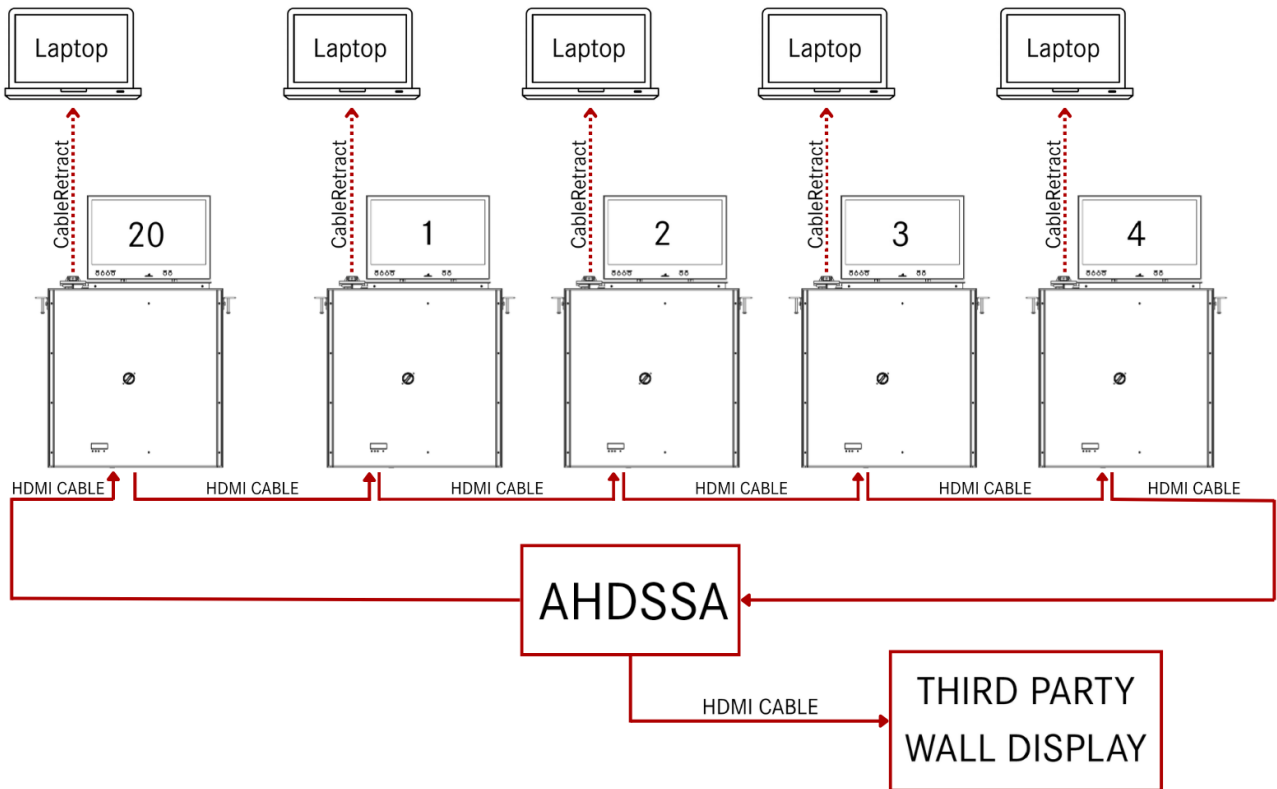

ARTHUR HOLM

Albiral Display Solutions SL · Fàtima, 25 · 08512 Sant Hipòlit de Voltregà · Barcelona, Spain · +34 938 502 376 · marketing@arthurholm.com · www.arthurholm.com
Arthur Holm is a registered brand of Albiral Display Solutions SL. Specifications subject to change without previous notice.

MakeYourMeetingsCount